

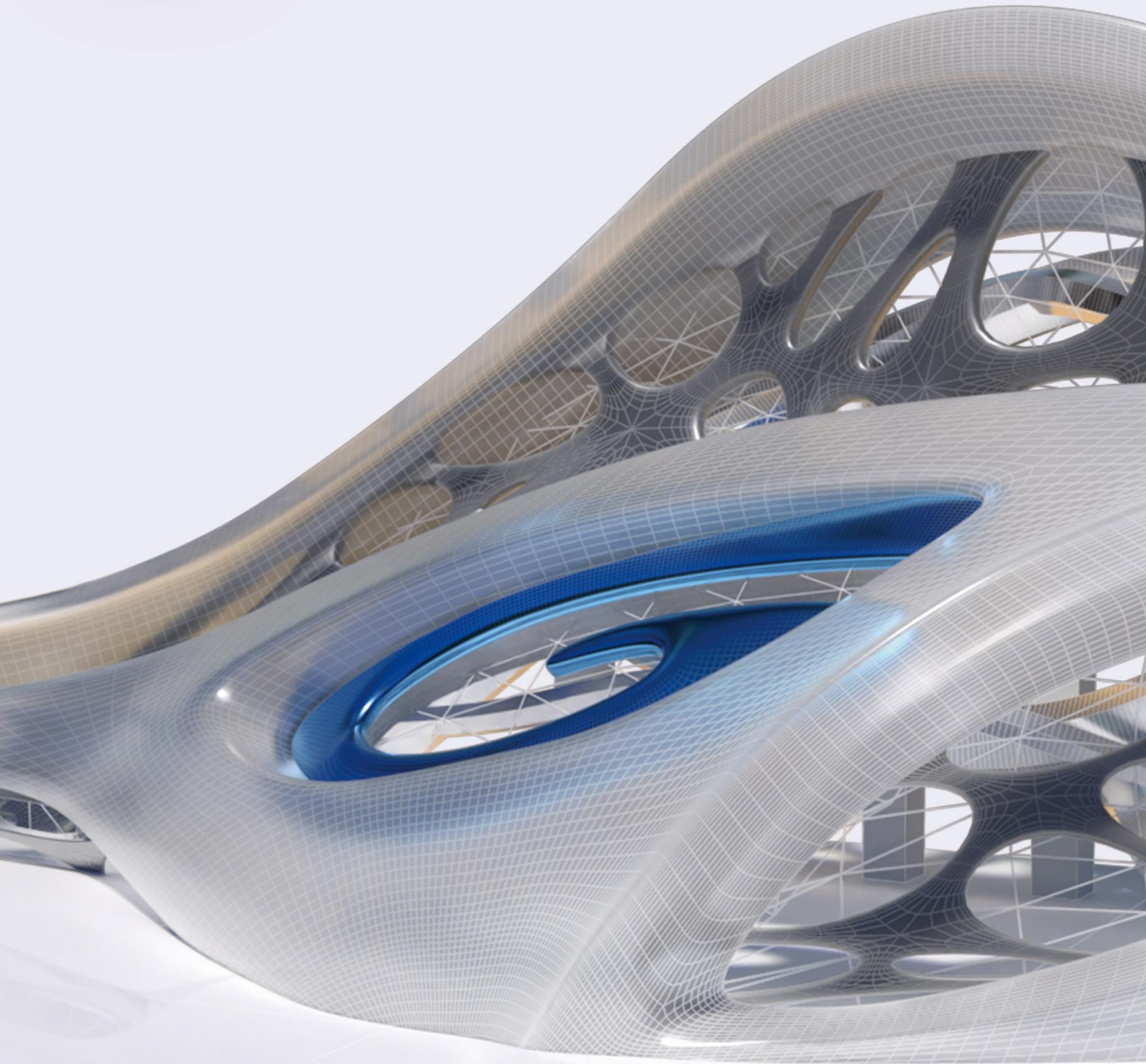

# ***Express Tools Guide***

---

***GstarCAD 2021***



# Table of Contents

## Block Tools

Replace Block with Another Block .....	5	Count Blocks.....	8	Convert Block to Xref .....	9
Copy Nested Objects.....	5	Change Block Color.....	8	List Xref/Block Properties.....	10
Explode Attribute to Text.....	6	Change Block Linewidth.....	8	Trim to Nested Objects.....	10
Attribute Increment.....	6	Change Block Text Angle.....	9	Extend to Nested Objects.....	10
Export Attribute Information....	7	Change Block Text High.....	9	External Reference Relocate....	11
Import Attribute Information....	7	Change Block Layer.....	9	Block Break.....	11
Statistics Blocks Number.....	8				

## Text Tools

Justify Text.....	21	Character Break.....	23	Position.....	24
Rotate text.....	21	Change Character.....	23	Delete Annotation.....	25
Change Text Style.....	22	Change One Character.....	23	Adjust Character.....	25
Chinese Characters Split.....	23	ChangeText Height/Width/Angle/			

**Text Tab** (The following features have been moved to Text menu from Express tools)

Text Match .....	12	Make Rtext.....	17	Scale .....	20
Change Text.....	13	Change Rtext.....	17	Text Outline .....	21
Text Align.....	14	Text Fit.....	18	Document Input.....	22
Text on Line.....	15	Extended Text Editor.....	18	Convert Text to Mtext.....	22
Arc-Aligned Text.....	16	Enclose Text with Object.....	18	Change Text Case.....	22
Text Mask.....	16	Automatic Text Numbering...	18		
Unmask Text.....	16	Text Incremental Copy.....	19		

## Dimension Tools

Area Table.....	24	Dimstyle Export.....	26
Change Dimension Text.....	25	Dimstyle Import.....	26
Change Dimstyle.....	25	Attach Leader to Annotation.....	27
Reset Dim Text Value.....	25	Detach Leaders from Annotation.....	27
Update Dimension.....	26	Global Attach Leader Annotation.....	27
Rapid Distance.....	28		

## Selection Tools

Get Selection Set.....	28	Get Selection by Layer.....	29
Select Filter.....	28	Get Selection by Color.....	30
Get Selection by Block Name.....	29	Get Selection by Object/Layer.....	30
Get Selection by Object Type.....	29	Get Selection by Object/Color.....	30
		Get Selection by Layer/Color.....	30

## Modify Tools

Layoutbypath.....	34	Overkill.....	39
Move/Copy/Rotate.....	35	Multiple Copy.....	40
Region Scale.....	37	Statistics Summation.....	41
Trim Enhancement.....	37	Break Object.....	41
Extended Offset.....	38		
Multiple Pedit.....	37		
Align Tool.....	33		
Arrange Tool.....	33	Areasum.....	36

(Areasum has been moved to Tools menu from Modify tools, Align Tool and Arrange Tool have been moved to Modify menu)

## Draw Tools

Superhatch.....	42	Spline to Pline.....	46
Breakline Symbol.....	43	Line to Pline.....	46
Spline to Line.....	45		

Pline Boolean.....	44	Cloud Line.....	47
--------------------	----	-----------------	----

(Pline Boolean has been moved to Modify menu and Cloud line has been moved to Draw menu from Express Tools)

## Tools

Command Alias.....	48	System Variable Editor.....	49	Make Linetype.....	50
Attach Xdata.....	50	List Object Xdata.....	50		

## Table Tools

Table Fill In.....	50	Add Bias.....	52	Selection Scale.....	53
Draw Table.....	51	Drag Multiple Lines.....	52	Add Row.....	54
Merge Cells.....	51	Drag Line.....	53	Add Column.....	54
Split Cells.....	52	Drag Segment.....	53		

Delete Row.....	54	Delete Table.....	55	CAD Table to Excel.....	55
Delete Column.....	54	Text Orientation Adjust.....	55		

**Coordinate Tools**

Export Coordinate.....	56	Coordinate Point.....	57	Change Z Coordinate.....	57
------------------------	----	-----------------------	----	--------------------------	----

**Drawing Tools**

Drawing Lock.....	58	Graphic compare.....	60
Drawing Compare.....	59	batchpurge.....	62

**AutoXLS Table Tools**

Create Table.....	63
Edit Table.....	63
Update Table.....	64
Update All the Tables.....	64
File Link Management.....	64
Path Settings.....	65
Selection Management.....	65

**GstarCAD Tools**

Drawing Scale.....	66	Modify Linewidth.....	69
Rotate Cursor.....	67	Cross to Break.....	69
Draw Axonometric Line.....	67	Control Break Width.....	69
Visual Extension.....	68	Modify Text.....	70
Normal Connect.....	68	Super Axonometric.....	71
Flex Connect.....	68		
Super Fillet.....	68		

**Print Tools**

Print Plt.....	71	Batch Print.....	72	Arrange Frame Automatically.....	72
----------------	----	------------------	----	----------------------------------	----



## Express Tools

The GstarCAD Express Tools contain a library of productivity tools designed to help you extend the power of your design. They are easy to use, easily integrated into your menus and toolbars, and cover a wide range of functions, including dimensioning, drawing, and selecting and modifying objects. GstarCAD Express Tools are organized on:

### Block Tools

**Replace Block with Another Block:** In the current drawing, you can use one block to replace another one, moreover, you can purge the unreferenced block when the operation is finished.

**Menu:** Expressools>Blocks>ReplaceBlock

**Command Entry:** BLOCKREPLACE

*Select a block to replace:* Double bed. Then select: OK

*Select the block to be replaced:* Sofa. Then select: OK

*Purge unreferenced items when finished? Yes/No*

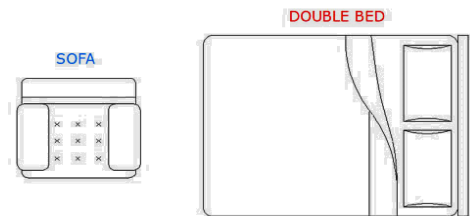

C

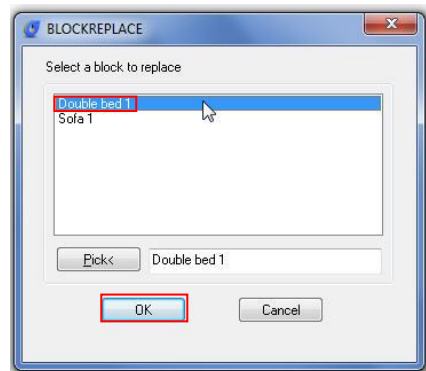

See the result below:

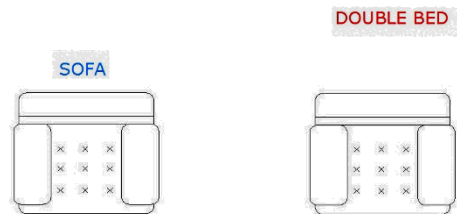
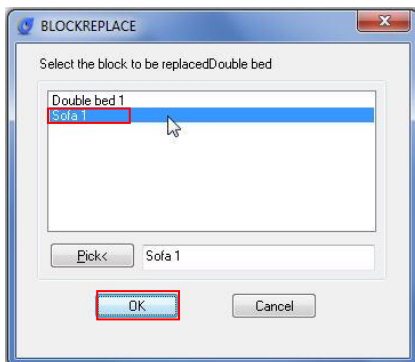

**Copy Nested Objects:** Copy objects in a xref or a block.

**Menu:** Express>Blocks>Copy Nested Objects

**Command Entry:** NCOPY

Command line prompts as follows:

*Select nested objects to copy:* Use an object selection method

*Base point:* Specify a point, or enter M for multiple copies

*Specify second point or <use first point as displacement>:* Specify a point

**Explode Attribute to Text:** Explode blocks, converting value of attributes to text objects.

**Menu:** Express > Blocks > Explode Attributes to Text

**Command Entry:** BURST

Command line prompts as follows: *Select entities: Use an object selection method*

For example: Explode attributes and convert them to text objects.

1. Select a block containing two attributes.

2. Block exploded and attribute values converted to text.



**Attribute Increment:** ATTINC command helps to specify attribute of blocks with incremental value, and to modify attribute value of blocks according to the sort method.

**Menu:** Express > Blocks > Attribute Increment

**Command Entry:** ATTINC

This command can increase block attribute value that contains a number or letter. When ATTINC command is on, as long as the drawing is not closed, when copying, inserting and deleting a block attribute in the drawing, the property number or letter can be updated automatically.

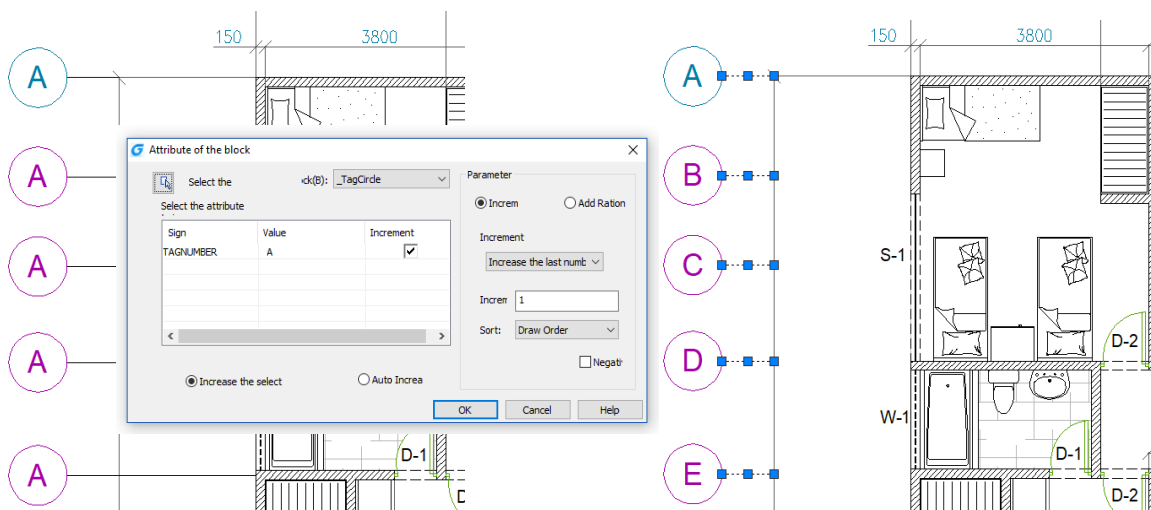

**Export Attribute Information:** Export block attribute to an external file in tab-delimited ASCII format.

**Menu:** Express>Blocks>Export Attribute Information

**Command Entry:** ATTOUT

Once performed ATTOUT command, specify file name and save path in "Enter output filename" dialog box, then command line prompts: *Select entities:* Specify the blocks whose attributes you want to export.

The block names and attributes are exported to the named file. If the file already exists, you are prompted before it is overwritten. You can easily view attributes in a spreadsheet format and edit individual attribute values. Then you can enter the new values into the drawing file, using the ATTIN command.

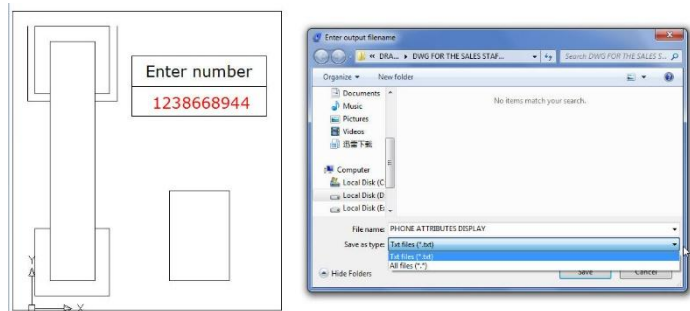

**Import Attribute Information:** Import block attribute to an external file in tab-delimited ASCII format.

**Menu:** Express>Blocks>Import Attribute Information

**Command Entry:** ATTIN

Using ATTIN and ATTOUT together, you can quickly make changes to attribute values for selected block references.

Once this command is performed, the "Enter input filename" dialog will pop up for the user to search file, import the block attributes along with the same handle and block name into the drawing, and make changes to the block attributes as well.

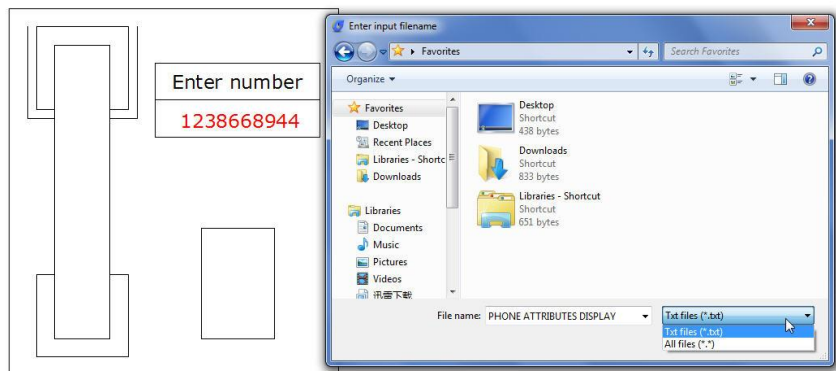

Once an attribute value is modified, it will be integrated into the specified block. It should be noticed that the imported file can't be attribute file exported by ATTOUT command, whereas the file format should be identical to that of ATTOUT command exporting.

Reads through imported file and processes each line when performing ATTIN command. If the block with the same handle and name is found in the process of treating lines, the modified attribute value of this block will be applied. If several blocks with the same handle and name are found, then system prompts whether to interactively assign saving data when processing these blocks. If "Yes" is selected, the data of each command line will be listed enabling selection of a block to apply this attribute. Press ENTER to skip to next line, press ESC to exit.

**Statistics Blocks Number:** You can statistics the quantity of various blocks through this function.

**Menu:** Express>Blocks>Statistics Blocks Number

**Command Entry:** TJNUM

Once this command is performed, its dialog box will pop up. Under Stat. Condition, you can input a block name, layer or check the options: Ignore the blocks in the same insert point and also ignore the scale.

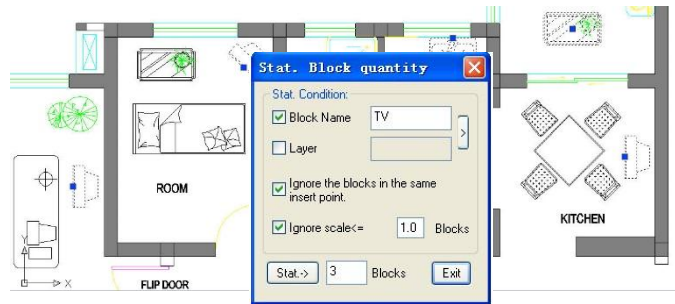

**Count Blocks:** This function is used to count the number of the blocks by list.

**Menu:** Express>Blocks>Count Blocks

**Command Entry:** BCOUNT

Operation steps:

1. Start the command, the command line prompts "Enter to select all blocks or ...".
2. You can press enter to select all the blocks within the drawing or by selecting blocks.
3. Once pressing "Enter" the system will display the result in the command line.

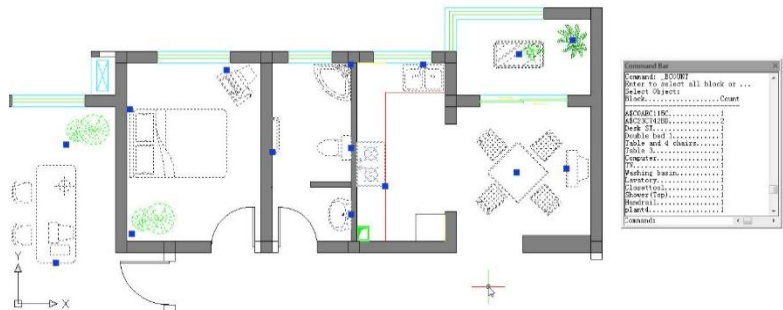

**Change Block Color:** Modify the block color quickly.

**Menu:** Express>Blocks>Change Block Color

**Command Entry:** bChgCol

Operation steps:

1. Start the command.
2. Input new color number, here we input 30 for example.
3. Select block objects, for which the color needs to be changed.
4. Finished modifying.

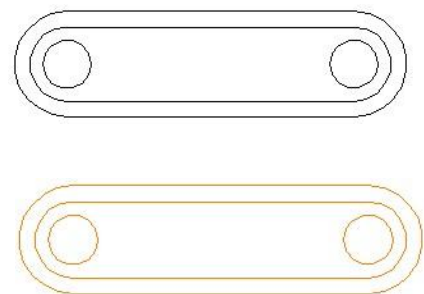

**Change Block Linewidth:** This function can modify block linewidth quickly.

**Menu:** Express>Blocks>Change Block Linewidth

**Command Entry:** bChgWid

Operation steps:

1. Start the command.
2. Input a new line width value.
3. Select block objects, for which the line widths need to be changed.
4. Finish changing the line width.

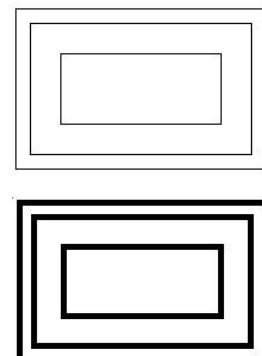

## GstarCAD Express Tools

**Change Block Text Angle:** This function can change the text rotation angle of the block and it only takes effect on text or mtext, attribute text can't be changed.

**Menu:** Express>Blocks>Change Block Text Angle

**Command Entry:** bChgAng

Operation steps:

1. Start the command.
2. *Input new text angle(comparative with @)<0>:* input 0.
3. *Select the block to change text angle:* then *Select objects:*
4. Finish changing the text angle.



**Change Block Text High:** This function can change the height of the block, it only takes effect on text or mtext, attribute text can't be changed.

**Menu:** Express>Blocks>Change Block Text High

**Command Entry:** bChgHei

Operation steps:

1. Start the command.
2. Input a new text height value.
3. Select objects whose text heights need to be changed.
4. Enter to finish the command.

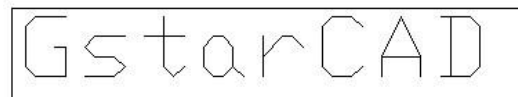

**Change Block Layer:** This function can change the block layer.

**Menu:** Express>Blocks>Change Block Layer

**Command Entry:** bChgLay

Operation steps:

1. Start the command.
2. Input target layer name.
3. Select block objects to change layer.
4. Press Enter. If the target layer exists, the selected block will be moved to the target layer, if a target does not exist, the software will make a new layer automatically and move the block object to the new layer.

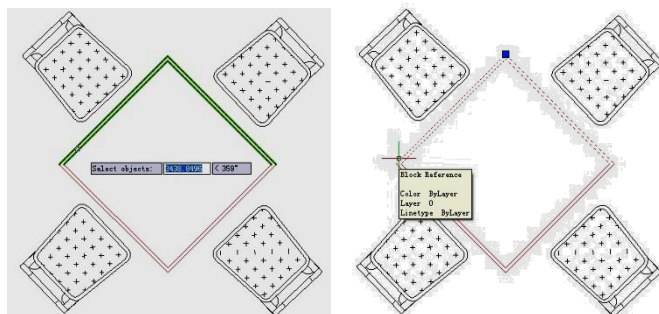

**Convert BLOCK to XREF:** Replace all instances of a standard block with an xref. Unbind xrefs that are bound.

**Menu:** Express>Blocks>Convert Block to Xref

**Command Entry:** BLOCKTOXREF

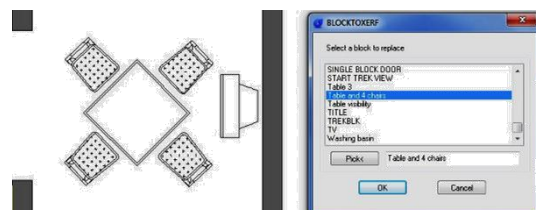

## GstarCAD Express Tools

-BLOCKTOXREF searches the entire drawing for references to a specified block name and replaces them with an xref that you specify. You can have the unreferenced block purged when done. In BLOCKTOXREF dialog box. Select a block to replace: Table and 4 chairs. Then select OK button.

-In Select a Xref file. Select the Xref you want. Then select Open button.

*Purge unreferenced items when finished? Yes/No*

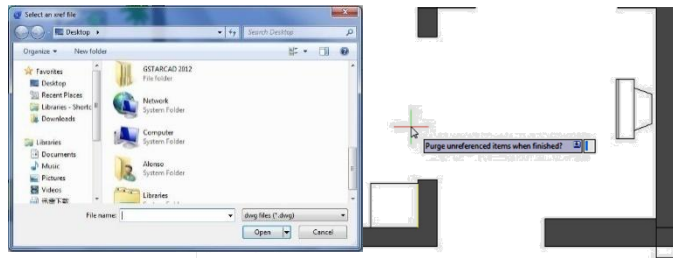

**List Xref/Block Properties:** List the type, block name, layer name, color and linetype of a nested object in a block or an xref.

**Menu:** Express>Blocks>List Xref/Block Properties

**Command Entry:** XLIST

Command line prompts as follow: *Select nested xref or block object to list:* Use an object selection method. After selecting an external reference, the "Xref/Block object" dialog box will display attributes of specified blocks and xref, including object type, block name, color and linetype.

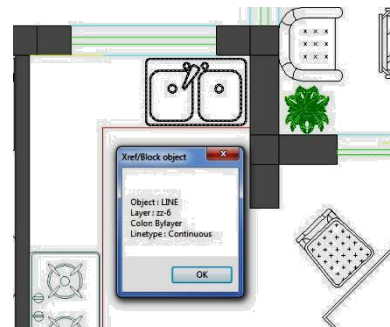

**Trim to Nested Objects:** Trims objects with a block as a cutting boundary.

**Menu:** Express>Blocks>Trim to Nested Objects

**Command Entry:** BTRIM

Command line prompts as follow:

*-Select objects or <select all>:* Select one or more blocks and press ENTER.

*-Select the object to Trim or Shift-select to Extend or [Edge/Fence/Crossing/Project]:*

Select object(s) or enter an option and press ENTER.

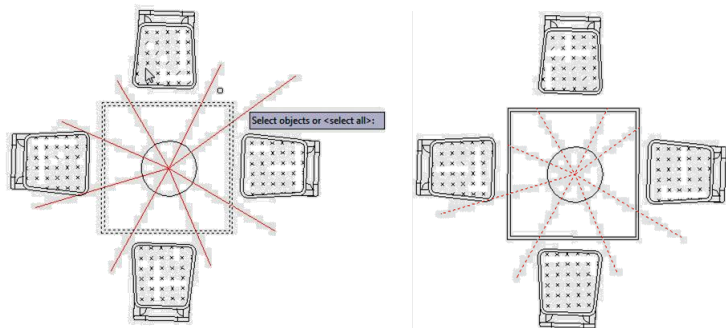

**Extend to Nested Objects:** Extends objects such as line segment, arc, polyline or ray to a block. Objects would be extended to a block as close as possible if they cannot intersect with each other.

**Menu:** Express>Blocks>Extend to Nested Objects

**Command Entry:** BEXTEND

Command line prompts as follow:

*-Select objects or <select all>:* Select one or more blocks and press ENTER.

*-Select the object to Extend or Shift-select to Trim or [Edge/Fence/Crossing/Project]:* Select object(s) or enter an option and press ENTER.

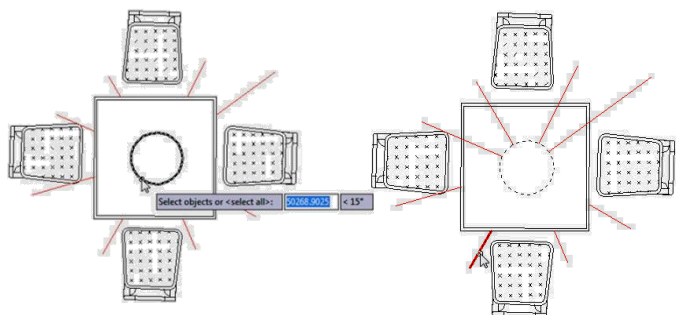

**External Reference Relocate:** With this function, our software can recognize the reference in the drawing and give you the reference state, if you want to select another reference path, click the “Relocate” button and the reference will be displayed in the drawing again.

**Menu:** Express>Blocks>External Reference Relocate

**Command Entry:** CHGXREFPATHa

Operation steps:

1. Start the command and a dialog box will pop up.
2. Select the external reference name which you want to modify.
3. If you click the “Relative Path” button, you will get a relative path of the reference; If you click “Relocate” button, the system will relocate the external reference.

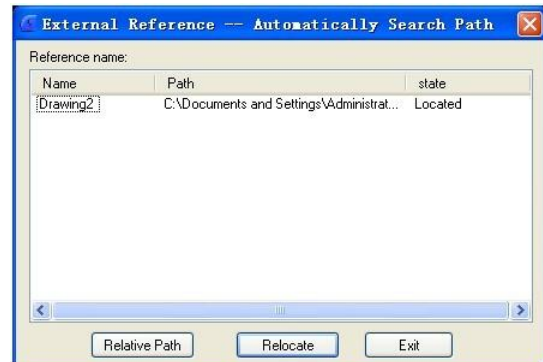

**Block Break:** Working with block references that represent symbols are essential in some industrial application drawings like electrical schematics, piping, etc.

But a headache comes when try to place these blocks accurately overlapping or even breaking other objects on your drawing. Now get rid of this headache with BLOCKBREAK command. This innovative tool is able to wipeout or breaks an object that is overlapped by a reference block.

For example, insome cases we may need to insert block symbols into a cable line in electrical schematic. And normally the cable line is required to be broken by the symbols at where the symbols are inserted. Similar request are also exists in other application designs.

**Menu:** Express tools>Blocks>Block Break

**Command Entry:** BLOCKBREAK

Block break dialog box:

**Name:** List all available blocks created in the drawing.

**Browse:** Browse to open specific drawing file.

**Pick:** You can pick an existing block reference in the current drawing.

**Scale:** Scales the block reference size according to X, Y and Z coordinates. Uniform Scale option keeps the original size of block reference.

**Rotation:** You can rotate a block reference by inputting an angle value or keep aligned.

**Process Mode:** You can use a block reference to break or wipeout objects when overlapping.

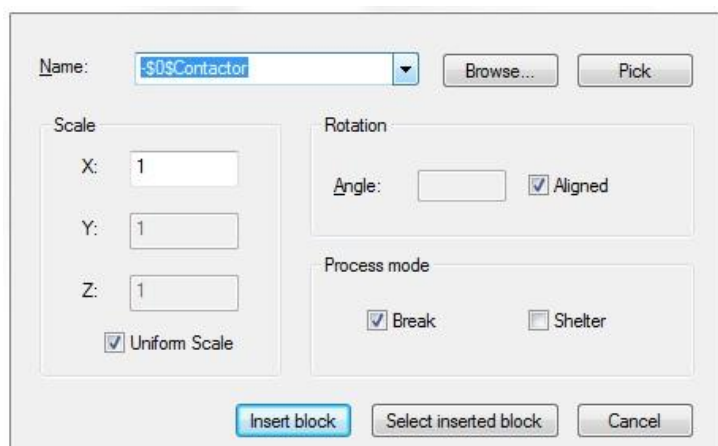



### Block Break Process Mode Illustration

**Break:** Breaks background object(s) when a block reference is overlapped.

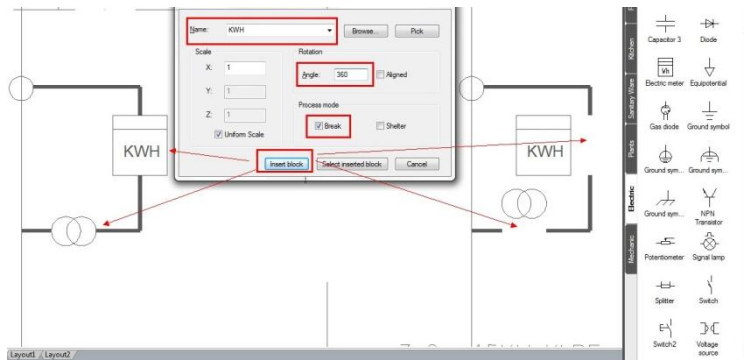

**Wipeout:** Wipeout background object(s) when a block reference is overlapped.

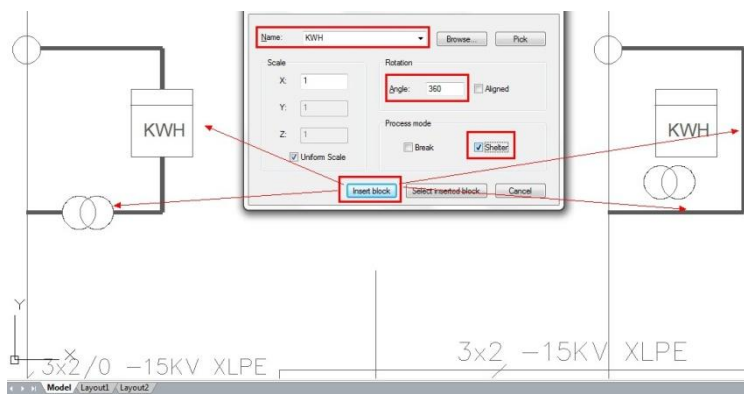

### Text Tools

**Text Match:** TextMatch is a specific tool to match both text and Mtext attributes in the current drawing, avoiding select and edit text attributes one by one.

**Menu:** Text > Text Match

**Command Entry:** Textmatch

After started the command, a message will display in the command line > *Select the sample text, Settings (S)*. If we enter the keyword S (settings) the follow Text Match Settings window will be display. From this settings window, we can see the text matching options such as: Text content, Color, Height, Angle, Align, Layer, Width factor and Style. And also you can select more than one option according to your need.

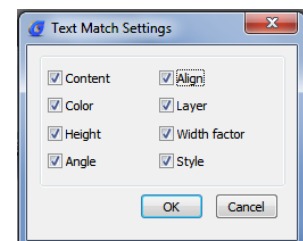



PART LIST				
SMALL BUSHINGS	3	STEEL		Welded ITEM 1-9
SHAFT	1	Q235A		
SUB - BASE PLATE	1	STEEL		16mm. thickness
MULTI-HOLE BASE PLATE	1	STEEL		16mm. thickness
THREADED SHAFT	1	Q235A		Welded ITEM 8
BUSHING "B"	2	Q235A		Welded ITEM 5
SUPPORT PLATE	1	STEEL		10.5mm. thickness
BUSHING "A"	1	Q235A		Welded ITEM 5
BMW - THREADED PIN "B"	1	Q235A		M12 x 1.4 x 104
BMW - THREADED PIN "A"	1	Q235A		M10 x 2.5 x 100
TILT PLATE	1	STEEL		15mm. thickness
DESCRIPTION	QTY	MATERIAL	TREATMENT	REMARKS
PARTS LIST				

B

PART LIST		
SMALL BUSHINGS	3	STEEL
SHAFT	1	Q235A
SUB - BASE PLATE	1	STEEL
MULTI-HOLE BASE PLATE	1	STEEL
THREADED SHAFT	1	Q235A
BUSHING "B"	2	Q235A
SUPPORT PLATE	1	STEEL
BUSHING "A"	1	Q235A
BMW - THREADED PIN "B"	1	Q235A
BMW - THREADED PIN "A"	1	Q235A
TILT PLATE	1	STEEL
DESCRIPTION	QTY	MATERIAL
PARTS LIST		

**Location:** Changes the text location by selecting and moving the text frame base point.

**Rotation:** Changes the text rotation according with the input value.

**Style:** Changes the text style by typing the style name in the command line.

**Text:** Find and replace text. Within this option there are three more: Single (I) / Re-enter (R) / Global (G):

**Single:** If you select one or more texts, this will match and change any context within the text selected in sequence (one by one).

**Re-enter:** This retype a new content by typing in the command line and then replace it.

**Global:** If you select one or more text, this will match and change any context within text group selected at once.

**Undo:** Like CTRL+Z, this will undo operation after select any other.

**Width:** Changes the frame area text by entering a new width factor value.

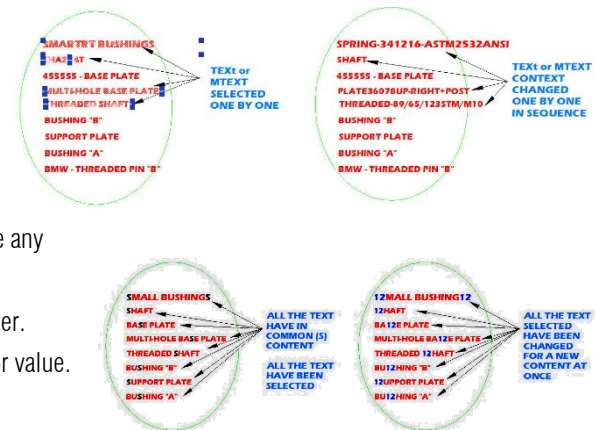
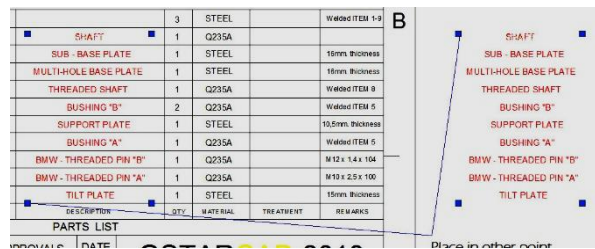

**Text Align:** As the name describes, this function is used to align text. You can select several texts in your drawing to align along X or Y coordinates, or along a line of specific direction.

**Menu:** Text > Text Align

**Command Entry:** Textalign

For example, when we create a table or part list and some contents are not in the correct location, using this tool improves the efficiency of adjusting text. After started the command, a message will display: *Please select object*: Then select the text(s) to be aligned. After select the text(s), a

ITEM	PART NO	DESCRIPTION	QTY	MATERIAL	TREAT
1	BMW-C-1	TILT PLATE	1	STEEL	TREA
PARTS LIST					
INIT	APPROVALS	DATE	APPROVALS	DATE	
ARP	Alonso Pizzali				
					Specify opposite corner: 0,000 0,32
					TITLE
					BMW CHASSIS ASSEMBL
					SIZE A2 CAGE CODE DWG NO. BWMC
					SCALE

message will display > *Select the align method: X axis (X) / Y axis (Y) / Two points (P):*

In this case, we choose Y axis align method and then specify a point to align the texts in the correct location. The result as follow:

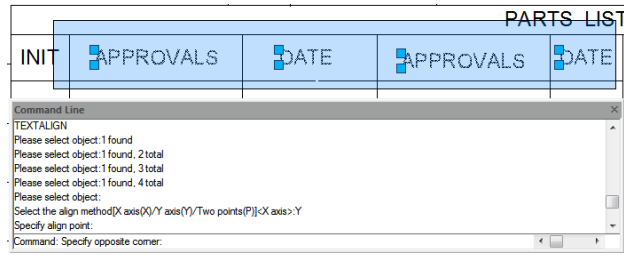

Another example, we choose X axis alignment method and then specify a point to align the texts in the correct location (end point of Leader). The result as follow:

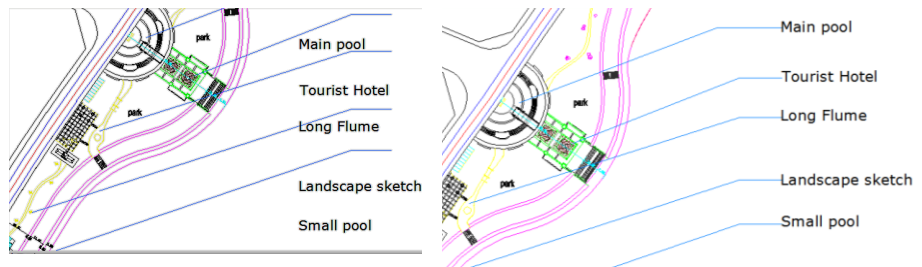

And finally, If we choose Two points (P) alignment method for and then specify two points to align the texts in the correct location (start and end point of Leader). The result as follow:

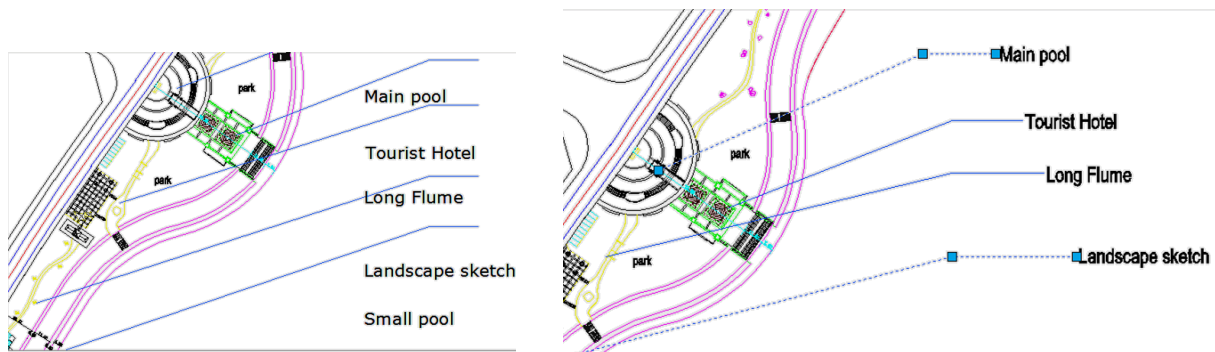

**Text on Line:** It can distribute the text uniformly along a selected spline, polyline or arc, but this can also create text online quickly for multiple curves.

**Menu:** Text > Text on Line

**Command Entry:** GC\_textonline

Operation steps:

1. Pick the "text on line" icon.
2. Click one certain point on the line as insert point of the character.
3. Input character, here, we input "GstarCAD".

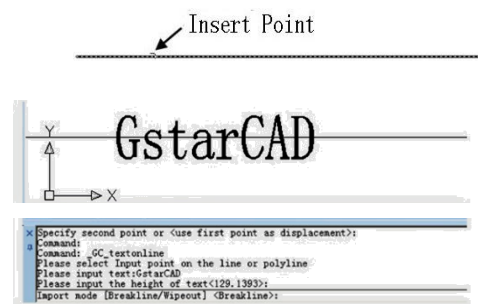

4. Enter the height of the character, here, we enter "3".
5. Select input mode, here we can choose "Breakline" or "wipeout".

**Breakline:** It breaks the line automatically according to insert point and length of the character. **Wipeout:** Generate one overlay area matched to the length of the character, cover the line with it and put the character in the insert point.

GstarCAD

**Arc-Aligned Text :** You can use this function to create Arc-Aligned Text.

**Menu:** Text > Arc-Aligned Text

**Command Entry:** ARCTEXT



Operation steps:

1. Start the command.
2. Select an Arc or an Arc- Aligned Text, as shown below.
3. Input texts in "Arc-Aligned Text" dialog box and set the relevant properties.
4. Click the "OK" button to finish creating Arc-Aligned Text.

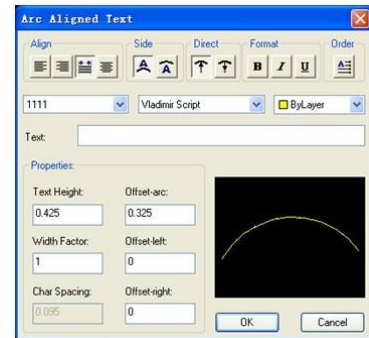

**Text Mask:** Place a mask object behind selected text or mtext. The rectangular mask is offset from the text by a specified value.

**Menu:** Text > Text Mask

**Command Entry:** TEXTMASK

*Text Mask*

**Text Mask**

Command line prompts as follows:

*-Current settings: Offset factor = 0.500000, Mask type = Solid, Mask color = 150*

*-Select text objects to mask or [Masktype/Offset]:* Select an option or text or press ENTER to exit.

Text objects are grouped together with the mask objects so that they are moved, copied and erased together. To update the mask after editing the text, run TEXTMASK again, and select the text item to be updated.

**Masktype:**

*Mask type currently set to Solid*

*Specify entity type to use for mask [3dface/Solid] <Solid>: Specify a type to use for mask.*

**3DFACE option:** Places a 3D Face behind the text.      **SOLID option:** Masks with a 2D solid in a specified color.

**WIPEOUT option:** Places the mask in front of the text.      **Offset:** Specify offset distance between shielded entity and text object.

*Enter offset factor relative to text height <0.500000>:* Specify a value, or select points to set the mask size.

**Unmask Text:** Removes mask from text that has been masked with the TEXTMASK command

**Menu:** Text > Unmask Text

**Command Entry:** TEXTUNMASK

Command line prompts as follow:

-Select text or MText object from which mask is to be removed.

-Select object: Use an object selection method.



**Make RText:** We can use RText function to display the content of a text file or the calculation results of a DIESEL expression in the drawing.

**Menu:** Text > Make RText

**Command Entry:** RTEXT

Operation steps:

1. Start the command and command line prompts.



Options: *Style:* Select a text style. *Height:* Specify a text height. *Rotation:* Specify a rotation value.

*File:* Use an external text file. *Diesel:* Use DIESEL code.

2. Capital letters “S”, “H” or “R” are used to set text style, text height, text rotation; If you enter “F”, a dialog box will pop up and you can select a text file(\*.txt) as RText display object. While the content of text file is changing, the RText is also changing automatically. If you select “Diesel” and a dialog box will pop up, the calculation results of a DIESEL expression can be displayed in the drawing.

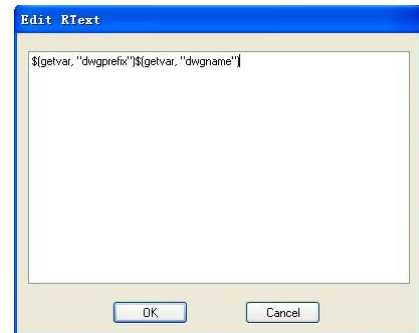

3. Input Diesel expression, here for example we input \$(getvar, "dwgprefix")\$(getvar, "dwgname") as shown below. The expression means to get current path.

4. Select insertion point to insert RText object.



5. Finish creating RText object.

**Change RText:** Allows you to edit existing remote text (Rtext) objects in the drawing.

**Menu:** Text > Change RText

**Command Entry:** RTEDIT

Operation steps:

1. Start the command.

2. Select an Rtext object.

3. You can enter the option to be modified, system will prompt several options.

4. Input “S” can specify text style; Input “H” can input text height value directly; Input “R” can specify text rotation angle; Input “E” will pop up a dialog box.

5. Finish modifying Diesel expression and click “OK”.

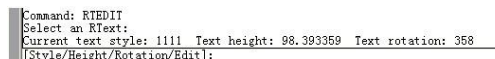



**Text Fit:** Stretches or shrinks text object(s) by selecting new start and/or end points.

**Menu:** Text > Text Fit

**Command Entry:** TEXTFIT

Command line prompts as follow:

-Select Text to stretch/shrink:

-Specify end point or [Start point]: Specify a new end point, or enter S to specify a new start point.

**Note:** The default uses the text's justification as the start point. If a new start point is specified, prompts are displayed to specify new points.

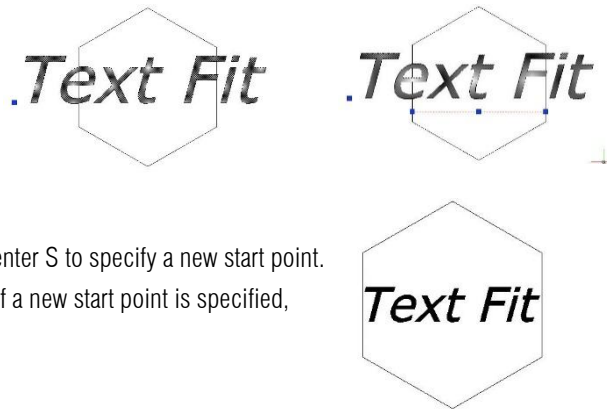

**Extended Text Editor:** This function is a specific function of GstarCAD, you can input some particular texts, for example, subscript text, single underline, double underline text and some special symbols and also you can set row spacing, alignment, text height and other parameters, moreover it can input and output \*.txt document. This function improves the CAD text editing ability greatly.

**Menu:** Text > Extended Text Editor

**Command Entry:** MMTXT

Operation steps:

1. Start the command and a dialog box will pop up.
2. Input corresponding texts in the dialog box.
3. Click "OK" to finish creating texts.

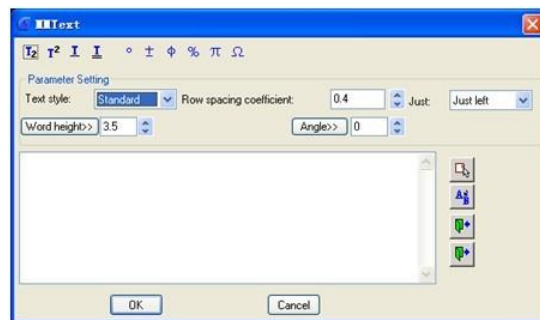

**Enclose Text with Object:** Place a circle, a slot, or a rectangle around each selected text or mtext object. The diameters of the circles can be constant or fitted to each object. The width and height of the slots and rectangles can be constant or variable.

**Menu:** Text > Enclose Text with Object

**Command Entry:** TCIRCLE

Usage Example:

-Circles: Constant radius( Fig 1). -Circles: Variable radius( Fig 2).

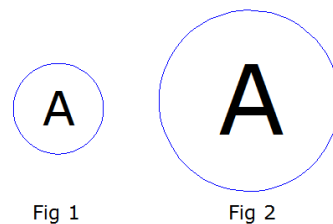

**Automatic Text Numbering:** Adds sequential numbering to text objects. The numbering can appear as a prefix, suffix or replacement text. After selecting one or multiple texts, you can set the text sorting method, the starting number and increment of text sorting and generated numbers placement mode.

**Menu:** Text > Automatic Text Numbering

**Command Entry:** TCOUNT



Operation steps:

1. Start the command.
2. *Select TEXT, MTEXT or ATTDEF objects.*
3. *Sort selected objects by [X/Y/Select-order]*

X: Places numbers by increasing the x-coordinate value of the selected text.

Y: Places numbers by decreasing the y-coordinate value of the selected text.

Select-order: Places numbers according to the order in which the text was selected. After specifying the method of order, the following prompts will be displayed in the command line.

4. *Specify starting number and increment (Start increment) <1,1>:* Enter the starting number and increment, separated by a comma, or press ENTER. **Note:** Negative increments (decrements) are supported. Precede decrements with a minus sign.

5. *Specify the placement of numbers in text [Overwrite/Prefix/Suffix/Find&replace..] <Prefix>:*, Enter an option or press ENTER

*Overwrite:* Replaces selected text strings with numbers.      *Prefix:* Adds the number as a prefix to text.

*Suffix:* Adds the number as a suffix to text.      *Find&replace:* Replaces a user specified text string with a number

Usage Example:

1. Starting number = 1, increment = 1 added as prefix:

Number one      **1** Number one  
 Number two      **2** Number two  
 Number three    **3** Number three

2. Starting number = 20, increment = -10 added as suffix:

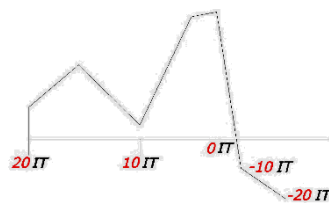

3. Starting number = 2, increment = 2, Overwrite:

**2**  
**4**  
**6**  
**8**  
**10**

**Text Incremental Copy:** This command can accomplish kinds of incremental methods for text.

**Menu:** Text > Text Incremental Copy      **Command Entry:** GC\_dztext

The incrementation dialog box is displayed:

*Distance:* Specify incremental Distance, you can input value directly or single click the button on the right to specify by the crosshair.

*Amount:* If do not specify Amount, the system will calculate the amount according to the initial points of the crosshair.

*Incrementation:* Specify the incrementation.

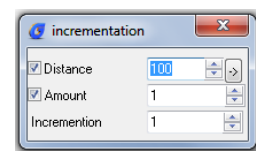

*Select Incremental Object:* If there are mixed letter cases and numbers in the text, user can specify different incremental objects.

1. Open Text Incremental Copy.
2. Select the incremental objects.
3. Set incremental methods, the completed incrementation effect is displayed.

*Free Incremental:* It is used when the Incremental Copy location is relatively free, for example: number of spare parts in the assembly drawing.

1. Open Text Incremental Copy.
2. Do not select Distance or Amount, please set incrementation as you need. Then select the text.
3. Specify incremental text location.

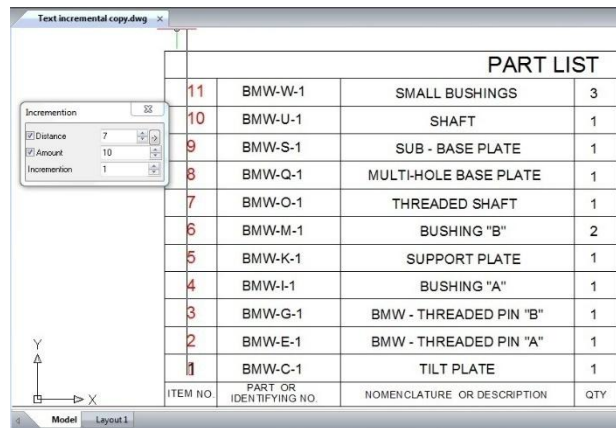

*Distance only:* It is used if the distance of incremental text is fixed, for example: number column in the form.

1. Open Text Incremental Copy.
2. Select Distance and do not select Amount, please specify Incrementation and Distance as you need. You can input value directly or single click the button on the right to specify by the crosshair. Then Select the text.
3. Specify incremental distance and direction. The system will automatically calculate the amount according to the initial points of the crosshair.

*Amount only:* It is used when you know the incremental amount and do not know the incremental distance.

1. Open Text Incremental Copy.
2. Select Amount and don't select Distance, please specify the Incrementation and Amount as you need. Then select the text.
4. Specify the incremental distance and direction. The system will place the incremental text between initial points of the crosshair as below:

*Distance and Amount:* You can fix the Amount and Distance first, and use the crosshair to specify the incremental direction.

**Scale:** This command can be used for single line text and multiline text, you can specify scale center and text height with this command.

**Menu:** Text > Scale      **Command Entry:** SCALETEXT

Operation steps:

1. Start the command.
2. Select objects which need to scale.
3. Specify scale center.
4. Specify the text height and Press enter to finish scaling.

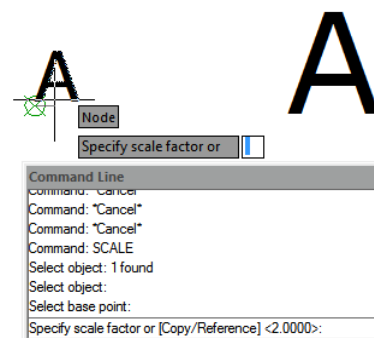

**Text Outline:** Text Outline function will split more thoroughly, after processing, texts are no longer words, but lines. When editing single line fonts, precision can be set to 1, set to higher numerical will make text warp, using truetype font from operating system, you can increase accuracy appropriately. The higher the accuracy, the shorter segments you will get, so you will get more segments.

**Menu:** Text > Text Outline

**Command Entry:** EXPLODETEXT

Operation steps:

1. Start the command.
2. Select objects to explode.
3. Press enter to finish. The text will break up into outline.

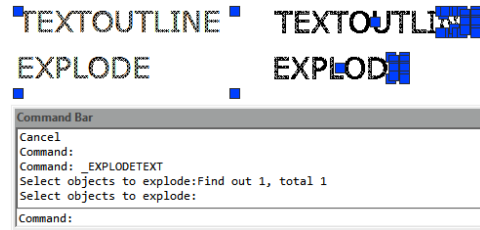

**Justify Text:** Change a text object's justification without changing its position. Works with text, mtext, and attribute definition objects.

**Menu:** Express > Text Tools > Justify Text

**Command Entry:** TJUST

Select objects: Use an object selection method.

*[Start/Center/Middle/Right/TL/TC/TR/ML/MC/MR/BL/BC/BR] <Start>: Choose the new justification*

Usage Example: Covert text to middle justified

-Text left justified.

-Text after justification change.

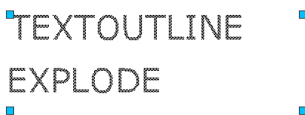

**Rotate Text:** Aligns text, mtext and block attribute objects to new orientation. Rotates text, mtext, and attribute definition objects so that they end up being as close as possible to horizontal or right-read (similar to the behavior of dimension text). Objects are rotated about their middle point in 180-degree increments. For example, if the text is upside-down, it becomes right-side up after a TORIENT operation. Similarly, left-read text becomes right-read text.

**Menu:** Express > Text Tools > Rotate Text

**Command Entry:** TORIENT

-*Select objects:* Use an object selection method

-*New absolute rotation <0>:* Enter a new absolute orientation angle for all selected text. Usage Example: -Text before rotation (Fig 3)

-Text after rotation specified angle of 0 degrees (Fig 4)



Fig 3



Fig 4

**Document Input:** This function can input document (\*.txt) to the drawing directly.

**Menu:** Text > Document Input

**Command Entry:** WJSR

Operation steps:

1. Start the command and a dialog box will pop up.
2. Select a TXT file.
3. Specify the insert point of the first line text.
4. Specify the height of text.
5. Specify line space.
6. Press enter to finish inputting.

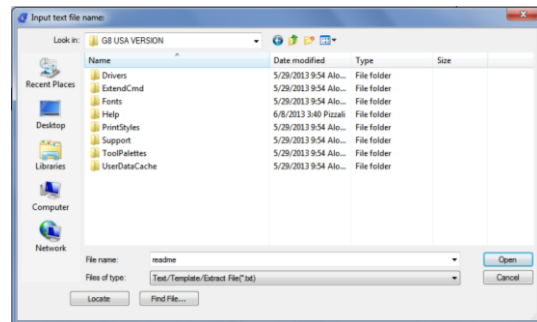

**Convert Text to Mtext:** Convert one or more normal text objects to Mtext.

**Menu:** Text > Convert Text to Mtext

**Command Entry:** TXT2MTXT

Operation steps:

1. Start the command.
2. Select objects: Here we select two text objects and convert them to Mtext object.
3. 1 Text objects removed, 1 MText object added.

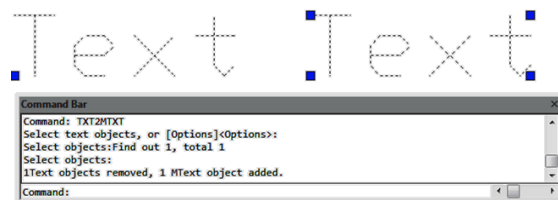

**Change Text Case:** Changes the case of selected text, mtext, attributes and dimension text.

**Menu:** Text > Change Text Case

**Command Entry:** TCASE

Command line prompts as follow:

-*Select object:* Use a selection method to select annotation objects.

-Execute this command, start "TCASE - change text case" dialog box, select an option.



**Change Text Style:** This function can change current text style for specified text and single line text, multiline texts are available.

**Menu:** Express > Text Tools > Change Text Style

**Command Entry:** CHGSTY

Operation steps:

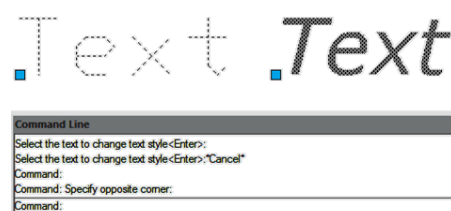

1. Start the command.
2. Select the text to change text style and you can modify several objects at a time. Then Press enter to finish the command.

**Chinese Characters Split:** This function can split single line texts to single text one by one, because the English word is a combination of several letters, this function only make sense for Chinese Characters.

**Menu:** Express > Text Tools > Chinese Characters Split      **Command Entry:** HZCF

Operation steps:

1. Start the command.
2. Select the text to be split.
3. Press enter to finish splitting.

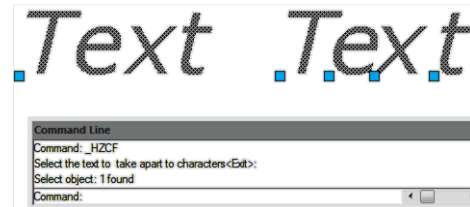

**Character Break:**      **Menu:** Express > Text Tools > Character Break      **Command Entry:** WZDD

Operation steps:

1. Start the command.
2. Select the text to break.
3. Specify the position for the break.

**Change Character:** This function can continuously revise multiple text objects, single line and Mtext are applicable.

**Menu:** Express > Text Tools > Change Character

**Command Entry:** \_DDEDIT

Operation steps:

1. Start the command.
2. Select the text to be replaced.
3. Input characters to replace and press Enter to finish.



**Change One Character:** This function can change texts in selected single line texts, you can just input characters to be replaced and characters to replace according to the prompts, Moreover it can be used in several single line texts at the same time.

**Menu:** Express > Text Tools > Change One Character      **Command Entry:** CHGTX

Operation steps:

1. Start the command.
2. Select the text to be replaced.
3. Input the characters to be replaced.
4. Input characters to replace.
5. Press enter to finish.

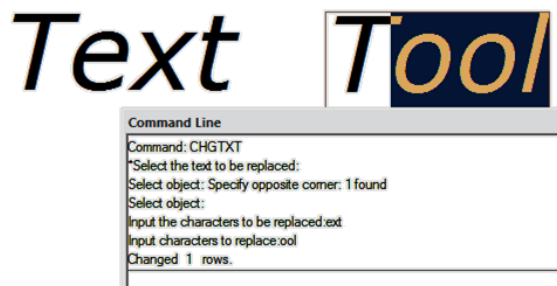

**Change Text Height/Width/Angle/Position:** This function is used to modify text height, text width, text angle and text position. You can click or select characters by window selection.

**Menu:** Express > Text Tools > Change Text Height/Width/Angle/Position

**Command Entry:** TXTHEI / TXTWID / TXTANG / TXTPOS

**Delete Annotation:** This function is based on this kind of circumstance, you can select one text annotation to be deleted, the software will register all the annotations in one layer, you can just press enter and all the text annotations will be deleted or you can select the texts by window selection and it will not affect the texts of other layers.

**Menu:** Express > Text Tools > Delete Annotation

**Command Entry:** WZOFF

Operation steps:

1. Start the command.
2. Specify a text annotation to be deleted. At this time you only specify the operation layer, if you directly press enter, the entire layer single texts will be deleted.
3. Select annotations to be deleted (you can select several objects by window selection) and press enter to finish.

**Adjust Character:** When the texts are mixed with Chinese characters, English letters and Arabic numerals, the text height will be different and the visual effect is not good. You can use this function to match the text height, but this function will explode the text's and it will be difficult to re-edit, so we suggest using this function after the user finished editing the drawing.

**Menu:** Express > Text Tools > Adjust Character

**Command Entry:** TTL2

Operation steps:

1. Start the command.
2. Select the text object which needs to adjust the height.
3. Press enter to finish.

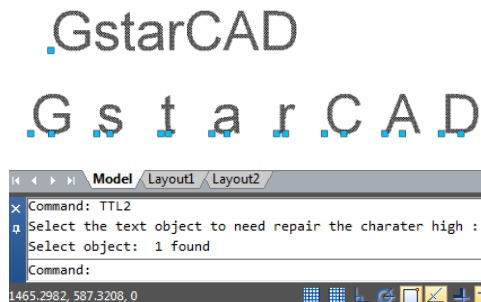

## Dimension Tools

**Area Table:** AREATABLE command automatically dimension and count the area of an enclosed object and export the result to a table in the current drawing area.

**Menu:** Express>Dimension>AreaTable

**Command Entry:** AREATABLE

The enclosed area or object can be marked with a number or area symbol, and the area table data can be generated at the same time. The area data can be exported to a text or table file. The values in the table can be changed automatically when the number or area size is changed.

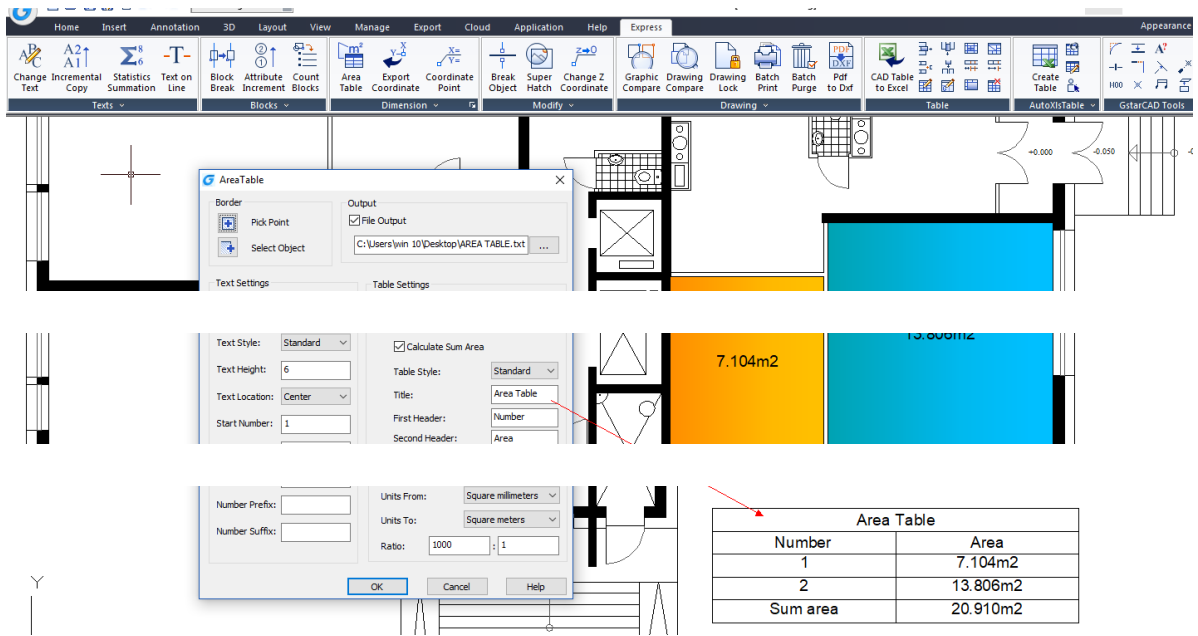

**Change Dimension Text:** Change the dimension content into the specified value.

**Menu:** Express>Dimension>Change Dimension Text

**Command Entry:** CHGDIMTXT

Command line prompts as follows:

- Select dimension objects:* Select a dimension
- Currently label content <129.9>, input new dimension text <practically measure dimension>:* Type a new value (130)

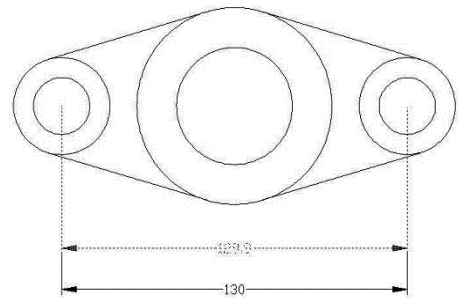

**Change Dimstyle:** Apply the current dimension style to the dimensions in the drawing.

**Menu:** Express>Dimension>Change Dimstyle

**Command Entry:** Dimstyle

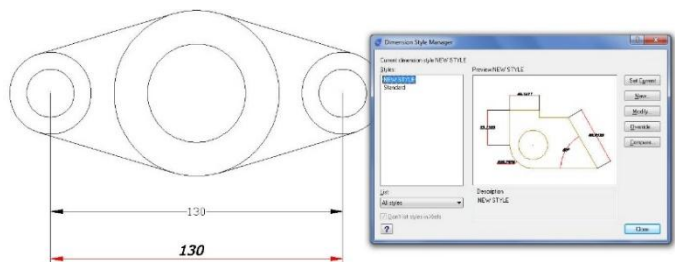

**Reset Dim Text Value:** Restore a measurement value to overridden or modified dimension text.

**Menu:** Express>Dimension>Reset Dim Text Value

**Command Entry:** DIMREASSOC

Command line prompts as follows: *Select object:* Select dimension objects with non-associative text or press ENTER to quit.

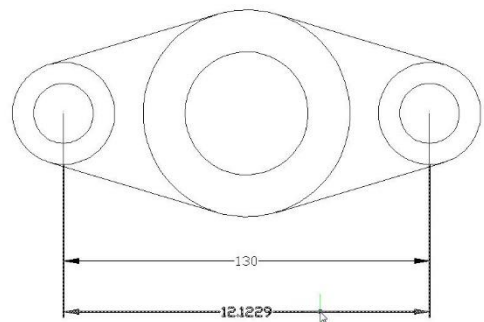



**Update Dimension:** Updates any other dimension(s) to the current dimension style you want to apply.

**Menu:** Express>Dimension>Update Dimension      **Command Entry:** DIMUPDATE

Command line prompts as follow:

-*Select a dimension for standard:* Select a dimension as a base.

-*Select a dimension, ensure update the dimension style:* Select dimension(s) to be update.

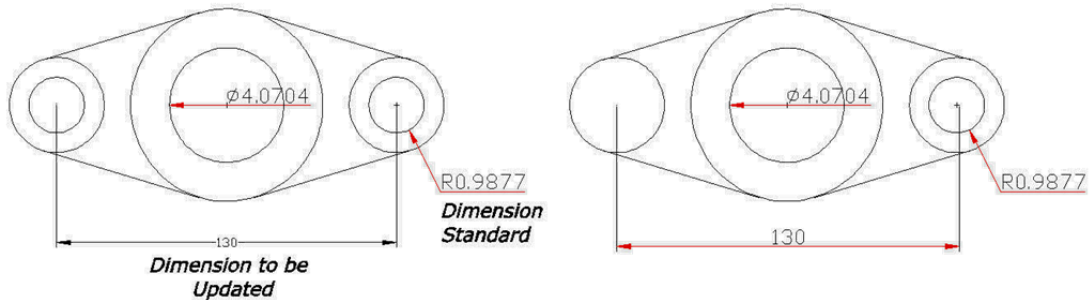

**Dimstyle Export:** Exports named dimension styles and their settings to an external file.

**Menu:** Express>Dimension>Dimstyle Export

**Command Entry:** DIMEX

Executing this command, starts the following dialog box:

**Export Filename:** Creates a DIM file. Enter the DIM file name or select Browse to locate the file. If the file does not exist, it is created. If the file does exist, a prompt requests permission to overwrite. The new file is an ASCII file.

**Available Dimension Styles:** Selects the dimension styles to write to the ASCII file. The current dimension styles are displayed. Each selected style is written to the file indicated in the Export Filename group.

**Text Style Options:** Saves either the dimension's Full Text Style Information or the Text Style Name Only to the ASCII file.



**Note:** Dimstyles are created and saved with the DDIM command. You must select at least one Dimstyle for the export to be successful.

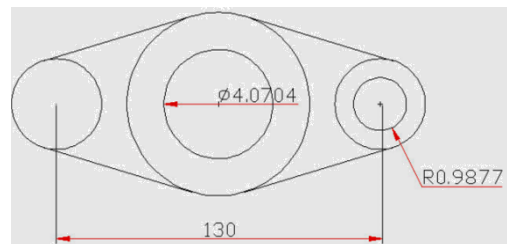

**Dimstyle Import:** Imports named dimension styles from a DIM file into the current drawing.

**Menu:** Express>Dimension>Dimstyle Import

**Command Entry:** DIMIM

Executing this command, starts the following dialog box:

**Import Filename:** Names the file you want to import. Enter an existing file name or select Browse to specify a DIM file to import. The file must be of the form generated by the corresponding DIMEX command. All dimension styles in the

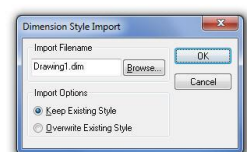
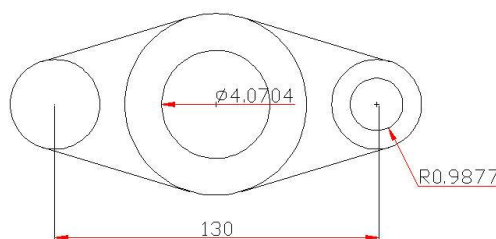

selected file are imported into the current drawing. Text styles are also imported.

**Import Options:** Includes Keep the Existing Style, to keep the dimension style in the current drawing and Overwrite Existing Style, to overwrite styles in the current drawing. The Keep the Existing Style option ignores the similarly named style being imported; Overwrite Existing Style uses the similarly named style being imported.

**Attach Leader to Annotation:** Attach leader line to Mtext, tolerance, or block reference object.

**Menu:** Express>Dimension>Attach Leader to Annotation

**Command Entry:** QLATTACH

-**Select Leader:** Select a leader

-**Select a dimension:** Select the Mtext, tolerance, or block reference object for the annotation.

*Use the QLATTACH command to attach leaders to Mtext*

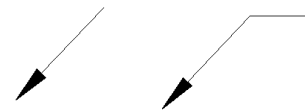

Usage Example:

-Select a leader, and then specify the Mtext object to attach.

-Separate leader line and Mtext objects.

-Leader line with mtext attached as one object.

At the **Select Leader:** prompt, you will be prompted until you select a leader object or abort the command.

At the **Select Annotation:** prompt, you will be prompted until you select an MText, Tolerance, or Block Reference object for the annotation.

**Detach Leaders from Annotation:** Detach leader line from mtext, tolerance, or block reference object.

**Menu:** Express>Dimension>Detach Leaders from Annotation

**Command Entry:** QLDETACHSET

-**Select objects:** Select leader line.

Usage Example:

-Select a leader line to detach from an mtext object.

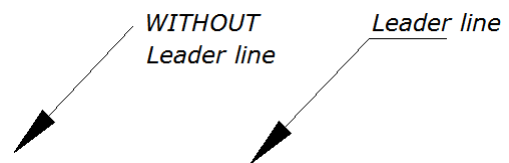

**Global Attach Leader to Annotation:** Globally attaches leaders line to mtext, tolerance, or block reference objects.

**Menu:** Express>Dimension>Global Attach Leader to Annotation

**Command Entry:** QLATTACHSET

-**Select objects:** Select one or multiple leader lines and annotation objects.

Usage Example:

-Select leader line(s), and mtext objects to attach.

-**Select objects:** Select one or multiple leader lines and annotation objects, the command line prompts: Number of unlocked leaders = 2, Number with



Fig 5

Fig 6

annotation detached = 2

-Leader with detached Mtext object (Fig 5)

-Leader attached to block object (Fig 6)

**Rapid Dist** : Rapid distance can measure distance and angle between 2D objects along X, Y axis rapidly by moving mouse.

**Menu:** Express > Dimension > Rapid Dist      **Command Entry:** RAPIDDIST

Distances that only can be measured along X, Y axis based on the position of your mouse, are displayed dynamically as you move your mouse over and between objects. Angles between the objects touched by distance lines, are displayed dynamically at the same time. The command only can be used under WCS, and only measure the 2D objects. And the angles of the blocks can't be measured.

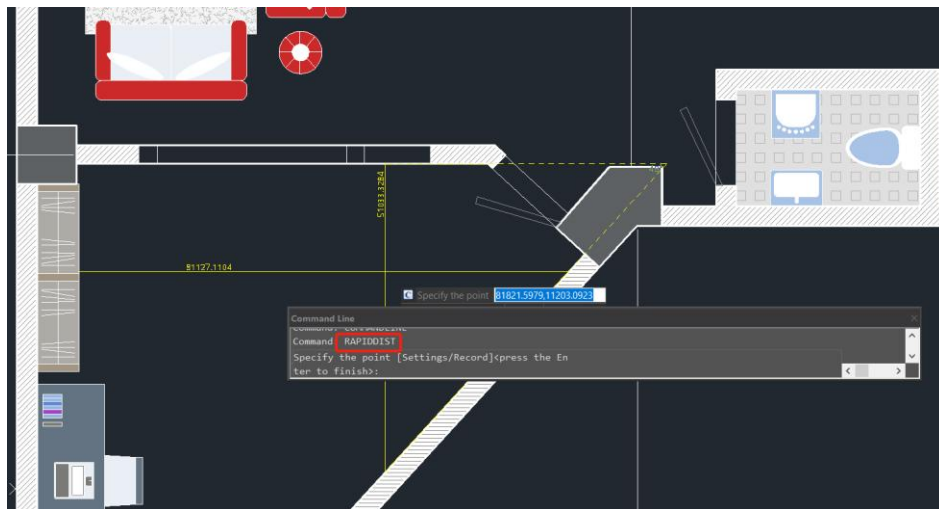

Type “**Settings**”, you can set unit conversion and scale in setting window.

Type “**Record**”, you can save the current result in command line window, which is convenient to check or copy data to other documents.

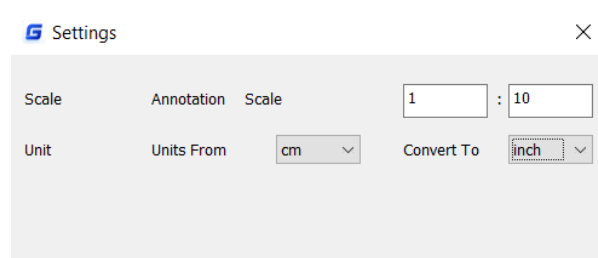



**Menu:** Express>Selection Tools>Get Selection by Block Name

**Command Entry:** GETBLKSEL

Operation steps:

1. Start the command.
2. Select object, specify a block name for operation.
3. Specify the region.
4. System will bring all the blocks with same name in region selected area into the selection.

**Get Selection by Object Type:** You can use this function to multi-select objects with the same entity type in specified area.

**Menu:** Express>Selection Tools>Get Selection by Object Type

**Command Entry:** GETENTSEL

Operation steps:

1. Start the command.
2. Select object and system will take the specified entity type as target type. Then specify region.
3. System will bring all the blocks with same entity type in region selected area into the selection.

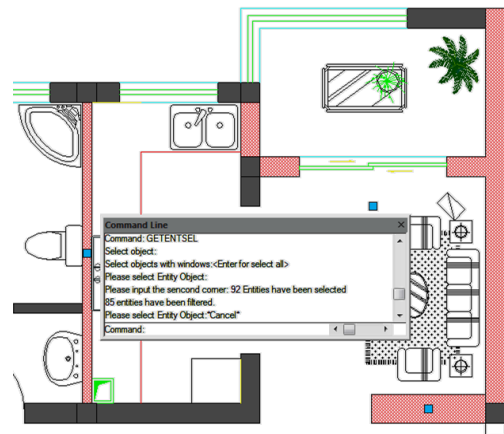

**Get Selection by Layer:** You can use this function to select all the objects in specified layer and specified region at one time.

**Menu:** Express>Selection Tools>Get Selection by Layer

**Command Entry:** GETLAYSEL

Operation steps:

1. Start the command.
2. Specify an entity which is in the target layer, then specify region.
3. System will

select all the objects in specified layer and specified region.

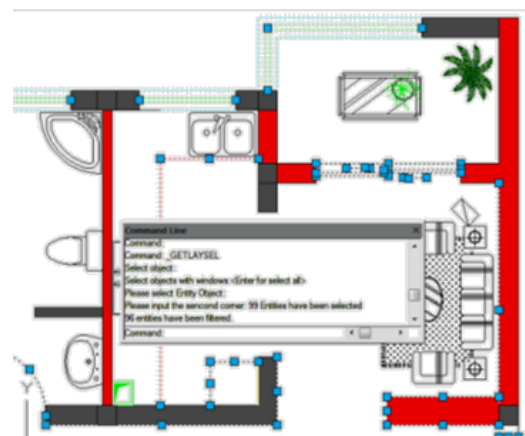

**Get Selection by Color:** Quick select the objects with the same color.

**Menu:** Express > Selection Tools > Get Selection by Color

**Command Entry:** GETCOLSEL

Operation steps:

1. Start the command.
2. Select one object and system will take the object's color as target color.
3. Specify region.
4. System will select the objects which have the same color as the target object automatically.

**Get Selection by Object/Layer:** Select entities by entity type and layer.

**Menu:** Express > Selection Tools > Get Selection by Object/Layer

**Command Entry:** GETENTLAYSEL

Operation steps:

1. Start the command.
2. Select one object and system will take the object layer as target layer.
3. Specify region.
4. System will select the objects which are in the same layer and with same entity type automatically.

**Get Selection by Object/Color:** Select entities by entity type and color.

**Menu:** Express > Selection Tools > Get Selection by Object/Color

**Command Entry:** GETENTCOLSEL

Operation steps:

1. Start the command.
2. Select one object and system will take the object's color as target color.
3. Specify region.
4. System will select the objects which have the same entity type and color as the target object automatically.

**Get Selection by Layer/Color:** Select entities by color and layer.

**Menu:** Express > Selection Tools > Get Selection by Layer/Color

**Command Entry:** GETLAYCOLSEL

Operation steps:

1. Start the command.
2. Specify an entity which is in the target layer.
3. Specify region.
4. System will select the objects which have the same color and same layer as the target object automatically.

## Modify Tools

**Align Tool:** Allows align selected objects such as: rectangle, circle, line, spline, arc, pline, block and even 3D model object along X or Y axis coordinates. This tool has different alignment methods, includes offset option for each axis and can be combined as well.

**Menu:** Express tools>Modify>Align Tool **Command Entry:** Aligntool

There are several align tool options within align tool window. All the options are design-intent to align objects X and Y axis as a reference.

- 1.- *Left object X axis Align:* Aligns the selected object(s) at left side X axis.
- 2.- *Center object X axis Align:* Aligns the selected object(s) at central side X axis.
- 3.- *Right object X axis Align:* Aligns the selected object(s) at right side X axis.
- 4.- *X offset:* Offset object(s) after select any X axis alignment option.
- 5.- *Top object Y axis Align:* Aligns the selected object(s) upwards Y axis.
- 6.- *Center object Y axis Align:* Aligns

the selected object(s) at central side Y axis.

- 7.- *Bottom object Y axis Align:* Aligns the selected object(s) downwards Y axis.

8.- *Y offset:* Offset object(s) after select any Y axis alignment option.

- 9.- *Specified object:* Aligns the selected object(s) to a specific object or any end point of it, after select any X or Y axis alignment option.

- 10.- *Specified point:* Aligns the

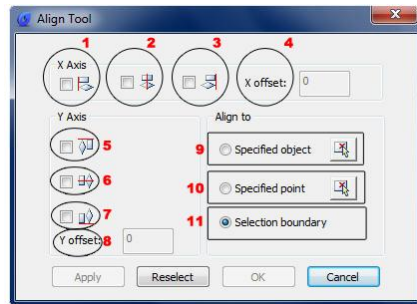

selected object(s) to a specific point of the second selected object, after select any X or Y axis alignment option.

- 11.- *Selection boundary:* This option is by default when you select any X or Y alignment option.

We can apply this tool to align a quantity objects (columns) in the correct place. Also notice that the objects are not aligned at same position each other, and also these are independent blocks. We will perform Top object Y axis alignment and specified object. After started the command Aligntool, a prompt message will display > *Please select the object to align:* Then select the objects in any order you want:

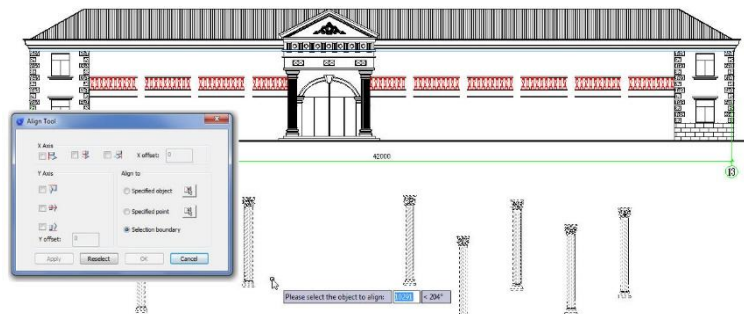

After you have selected the objects, the Align tool settings window will pop up: first we have to check the option Top object under Y axis alignment. After check this option the objects (columns) will be aligned at same level:

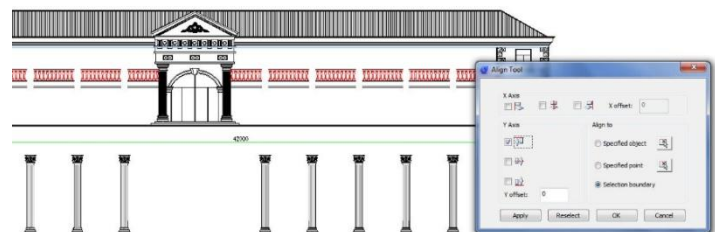

After the objects have been aligned, we have to select the option specified object under Align to. Then select the object (blue line) where we want to align and place the objects. Finally you will get a faster result performing this operation:

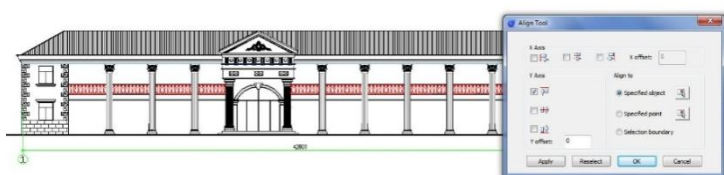



**Arrange Tool:** ArrangeTool can quickly adjust the arrangement of multiple objects. It can align multiple objects at left, right, top, bottom and center and also can arrange vertical or laterally.

**Menu:** Express tools>Modify>Arrange Tool **Command Entry:** ARRANGETOOL

For example, ArrangeTool makes the bearings evenly distributed in the shaft. ArrangeTool supports real-time preview when user adjusts the parameters. In addition it supports distribution specifies.

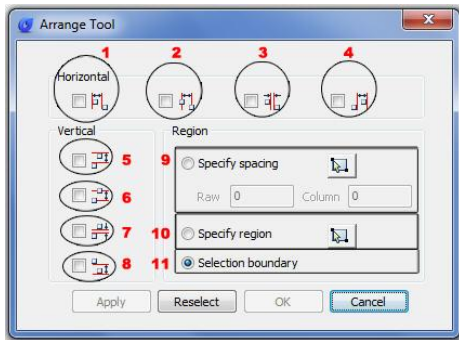
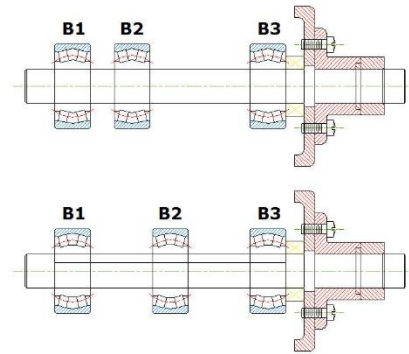

There are several arrange tool options within arrange tool window. All the options are design-intent to arrange object's position horizontally or vertically. This tool can work at least with 2 or more objects selected.

**1.-Left horizontal arrangement:**

Arranges selected objects horizontally, taking leftmost object as arrangement reference.

**2.-Middle horizontal arrangement:**

Arranges selected objects horizontally in two ways (top or bottom left object).

**3.-Nearest side horizontal arrangement:**

Arranges selected objects horizontally to the nearest side object taking top left object as reference.

**4.-Right horizontal arrangement:**

Arranges selected objects horizontally, taking right edge of the leftmost object as arrangement reference.

**5.-Top vertical arrangement:** Arranges selected objects vertically, taking top

object as arrangement reference.

**6.-Middle vertical arrangement:**

Arranges selected objects vertically, taking middle of the top object as arrangement reference.

**7.-Nearest side vertical arrangement:**

Arranges selected objects vertically to the nearest side object taking top object as reference.

**8.-Right vertical arrangement:**

Arranges selected objects vertically, taking bottom edge of the top object as arrangement reference.

**9.-Specify spacing:** Can be combined with any horizontal and vertical options. Also you can input a value for column in horizontal objects

arrangement and raw for vertical objects arrangement.

**10.-Specify region:** Can be combined with any horizontal and vertical options by specifying the start and end points of the new region. Then, the objects selected will be arranged according to the new region.

**11.-Selection boundary:** After selecting objects, the arrange tool dialog box pop up, this option is selected by default, so just you need to select any horizontal or vertical arrangement option. And the objects selected will be arranged horizontally or vertically and equidistant each other according to the boundary.

**Remarks:** Under Specify spacing there are 2 titles: Raw and Column. Raw value only works if we combine it with any vertical arrangement option. And Column value works with any horizontal arrangement option.

For example, we can apply this for arrange the part numbers distribution over the leader lines. Notice that the objects to be selected are Mtext and will be distributed according to the top object level as a reference.

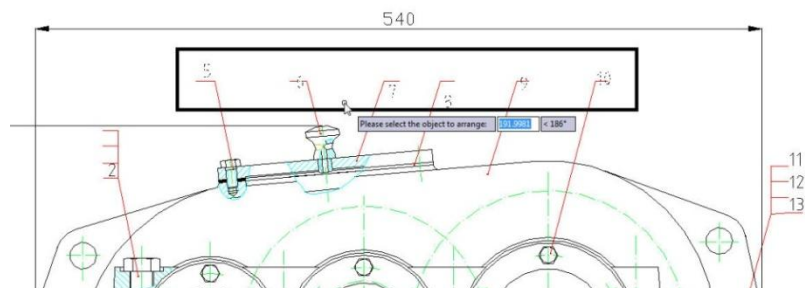

After started the command, a prompt message will display > *Please select the object to arrange:*

Then select the part numbers. After select the part numbers, the arrange tool window will pop up, select the option: Specify spacing and then check or select the option: Top vertical arrangement. See the result below:

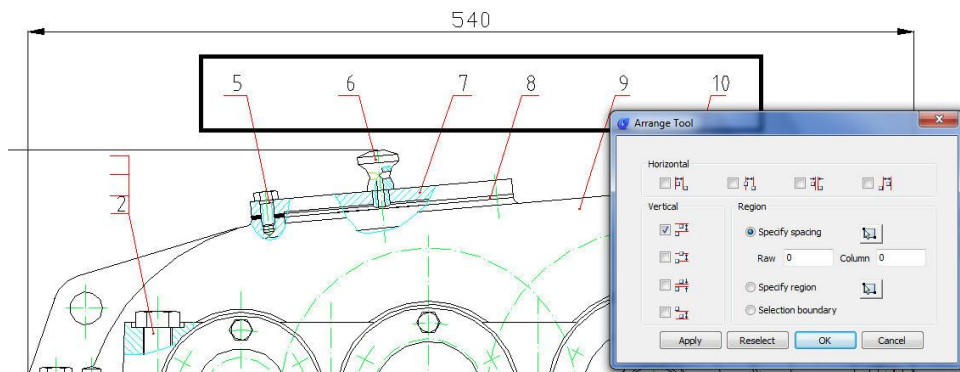

**Layout By Path:** Unlike common array function, LayoutByPath distributes object copies along a path (curve) with a variety of array options. Users can choose random, division and measure options and array in different directions along the path.

**Menu:** Express tools>Modify>Layout by path

**Command Entry:** Layoutbypath

For example, on mapping drawing, we can apply this tool to array the discontinuous central axis of the road or highway as shown in the picture:



After started the command Layoutbypath, a message will display in the command line>*Please select the object to array:*

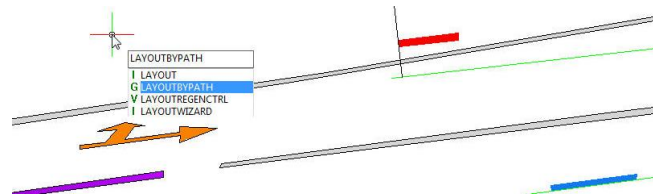

After select the object, a prompt message will display:

*Please specify the base point:*

The base point is the point where you want to start doing array from the object. We can select the low left end point of this object:

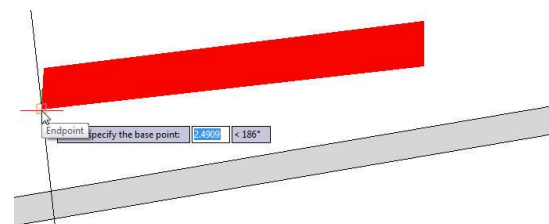

After select base point of the object, a prompt message will display:

*Specify the object's direction along the curve <Y axis of WCS>:*

This message is important because this will play with the object's direction along the path. Because we select the end low point of the object as base point, we have to specify a parallel point direction to keep the object parallel along the path (long green line):

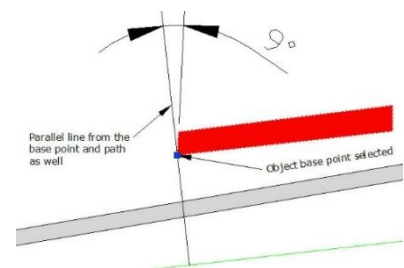

After specify the object's direction, a prompt message will display:

*Please select the curve:*

Then select the long green line. This line is the curve or path that the object will follow.

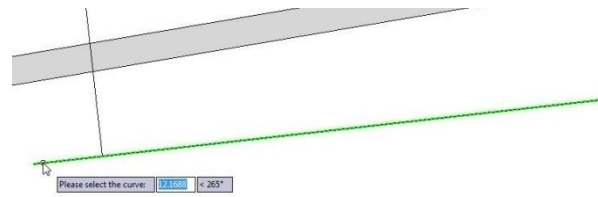

After select the curve or path, a prompt message will display:

*Specify select along which side of the curve <left side or forward direction>:*

This message is also important because we will specify the side which the object will be array. For example, we specify left side of the curve as shown in the picture.

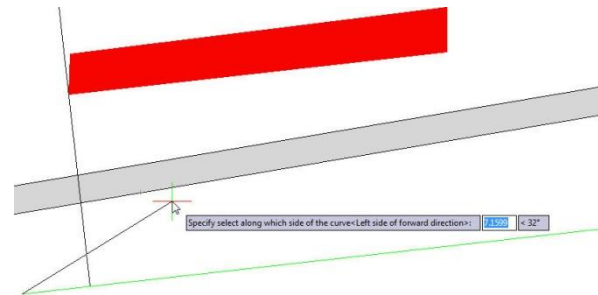

After specify the side of the curve, a prompt message will display: *Select the method Random (R) / Division (F) / Measure (D):*

There are three options random, division and measure:

*Random:* This allows to array the selected object along the path in a specify point according to user's need.

*Division:* This allows to array automatically the selected object along the path by inputting the number of objects.

*Measure:* This allows to array automatically the selected object along the path by inputting the distance value.

For example, if we do not know the distance between objects but we know the objects quantity, we can select the option Division:

After select the option, a prompt message will display:

*Enter the number:* And we enter the value 11

After enter the value, a prompt message will display:

*Pick a point on the curve as start point (Distribute from the end curve when selection is empty):*

Then pick one of the end points of the curve:

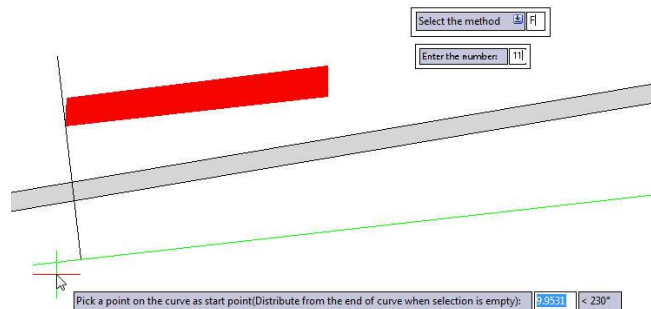

After pick the point of the curve, you will get accurate result: And also you can repeat the same array option for the other blue central axis of the road.

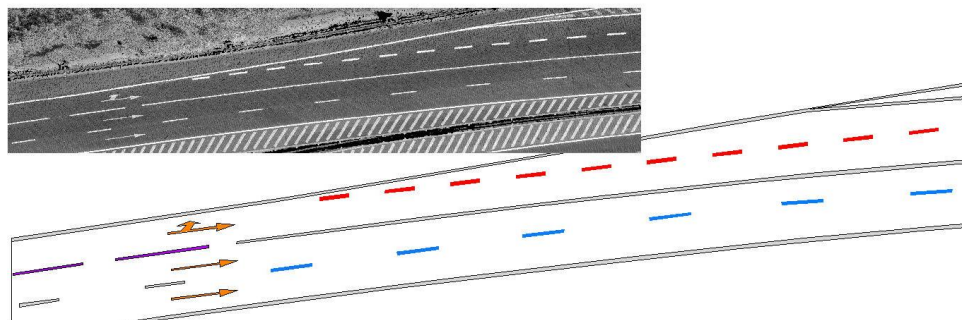



**Region Scale:** You can select a region of a drawing to be cut and copied to a new location.

**Menu:** Express tools>Modify>Region Scale

**Command Entry:** ICAD\_DYJT

Command line prompts as follow:

*Specify left up corner point for full-page proof:* Select a region from left up to right down corner

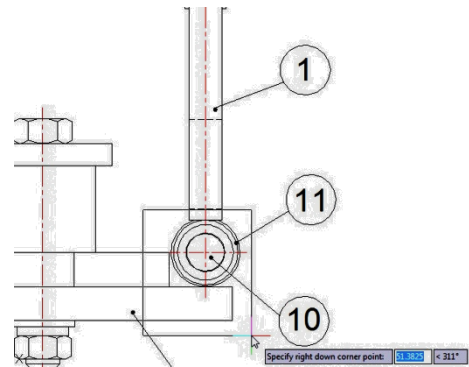

*Specify the position to copy:* Specify any place you want to copy to the selected region

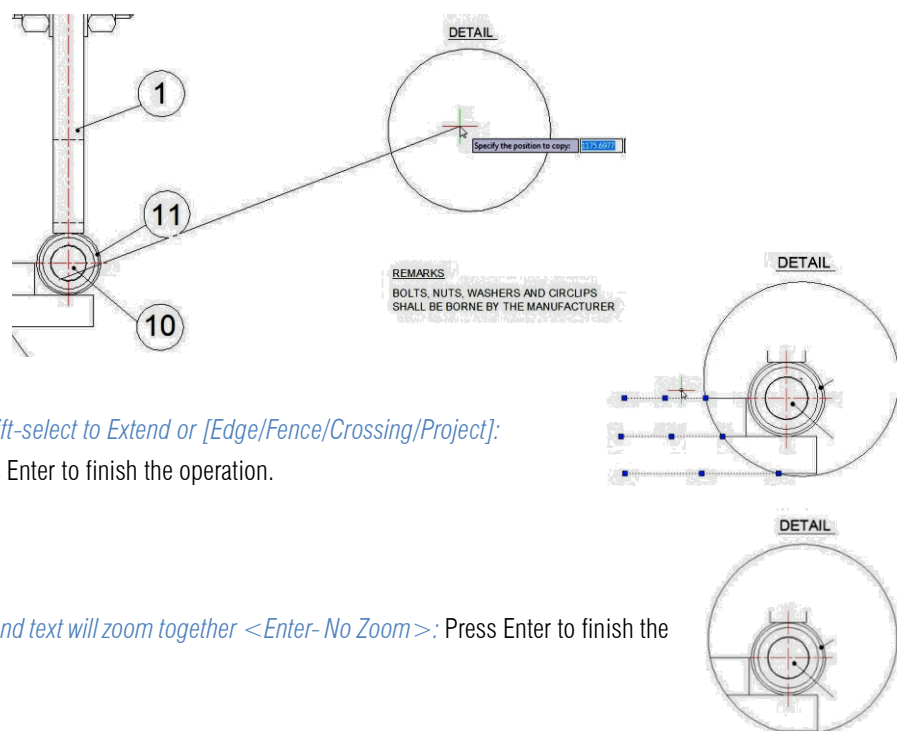

*Select the object to Trim or shift-select to Extend or [Edge/Fence/Crossing/Project]:*

Select objects to trim or press Enter to finish the operation.

*Input zoom scaling, the block and text will zoom together <Enter- No Zoom>:* Press Enter to finish the operation.

**Trim Enhancement:** Trim one side of an object which is intersecting with other objects. The object can be polyline, line, circle, arc, ellipse, image or text.

**Menu:** Express tools>Modify>Trim Enhancement

**Command Entry:** EXTRIM

Operation steps:

1. Start the command.
2. Select an object as trim reference, here we select the rectangle for example. (Fig 11)
3. *Specify the side to trim on.* (Fig 12)
4. Here we select the internal point of the rectangle, you will see that the internal lines of the rectangle are trimmed. (Fig 13)



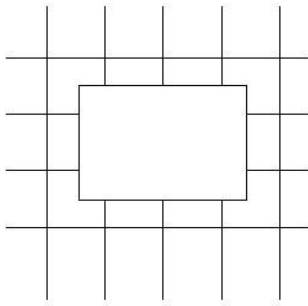

Fig 11

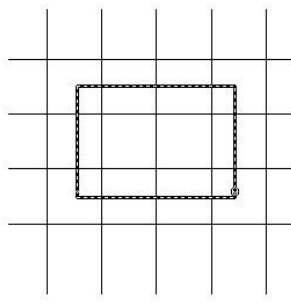

Fig 12

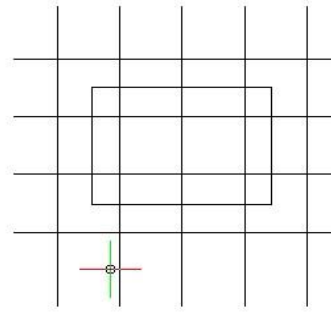

Fig 13

**Extended Offset:** This enhanced version of the OFFSET command offers several advantages over the standard command, including layer control, undo, and a multiple option.

**Menu:** Express tools>Modify>Extended Offset

**Command Entry:** EXOFFSET

1. *.Specify offset distance or [Through] <T>:* Specify the offset distance or through point
2. *.Select object(s) to offset or [Options/Undo]:* Select an object to offset, change options or undo
3. *.Specify an option to set [Distance/Layer/GapType]:* Specify an option

EXOFFSET Options:

*Distance:* Specify the offset distance or through point

*Layer:* Specify the layer for new objects. Current Layer or Source Object Layer

*GapType:* Sets or changes the offset mode as controlled by the OFFSETGAPTYPE variable. The options are: Normal, Fillet or Chamfer.

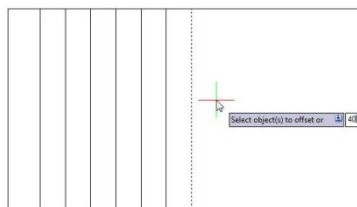

Distance

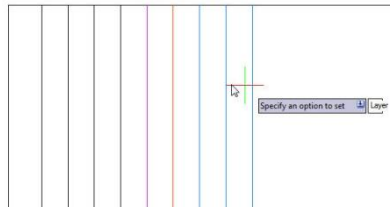

Layer

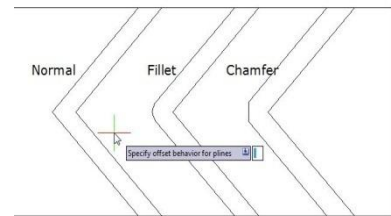

GapType

**Multiple Pedit:** This command is almost the same as the standard command.

**Menu:** Express tools>Modify>Multiple Pedit

**Command Entry:** MPEDIT

1. Start the command.
2. *Select object*
3. Specify an option to set *[Open/Close/Decurve/Fit/Linetype-mode/Spline/Width/eXit] <eXit>:*

Example to close plines:

1 .*Select object*: select plines which you want to close.

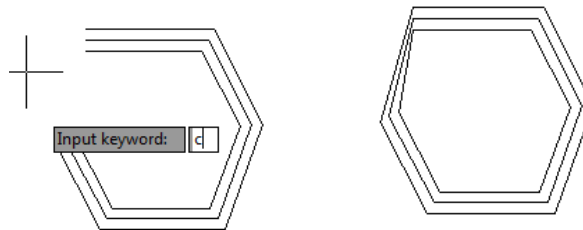

2 .*[Open/Close/Decurve/Fit/Linetype-mode/Spline/Width/eXit] <eXit>*:Input keyword: C and enter.

3 . You will get the plines closed.

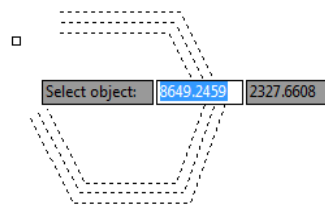

**Overkill:** This function can not only manage overlapped lines, circles, Plines linear objects etc, but can also manage entire coincident blocks, texts, dimensions and regions .Moreover, remove does not simply mean delete, it judges by layer, color, line type and many relevant attributes and can delete or connect coincident parts of 2D and 3D Plines, circles, arcs and overlapping line parts. Using this option can not only delete redundancy objects, but can also avoid editing and printing problems caused by overlapped objects.

**Menu:** Express tools > Modify > Overkill

**Command Entry:** OVERKILL

Start the command and the command line prompts as follow: *Select objects*: Select the objects to be compared and deleted. In the overkill dialog box, you can set-up the object comparison, comparison precision (distance between objects) and the object type. After selecting the options according to your need, select OK.

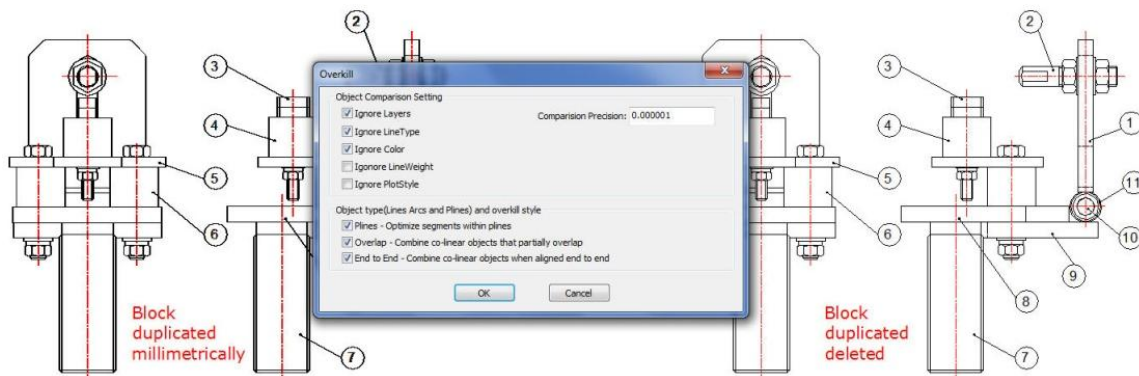



**Multiple Copy:** Copy multiple objects with Repeat, Array, Divide and Measure options.

**Menu:** Express tools>Modify>Multiple Copy

**Command Entry:** COPYM

Start the command and the command line prompts as follow: *Select objects:* Select the objects to be copied

*Base point:* Specify a base point

*Second point or [Repeat (last)/Divide/Measure/Array (dynamic)/Undo] <exit>:* Select a second point or any option

Options:

*Repeat:* Repeat the last copy using the same offset distance.

*Divide:* Linear divide option. Prompts for an additional point and the number of copies to make. Makes evenly spaced copies of the selected objects between the base point and the second selected point

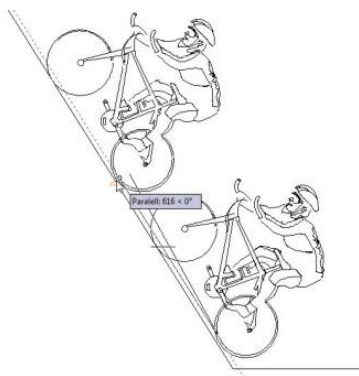

Repeat

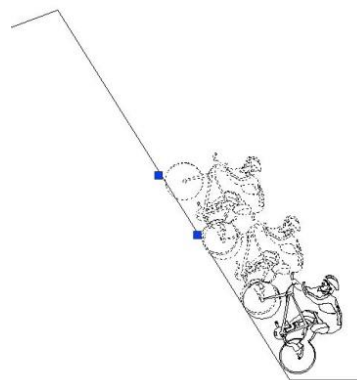

Divide

*Measure:* Linear measure option. Prompts for an additional point and the distance between copies. Makes evenly spaced copies at the specified distance between the base point and the second selected point.

*Array:* Displays the Array Options prompt.

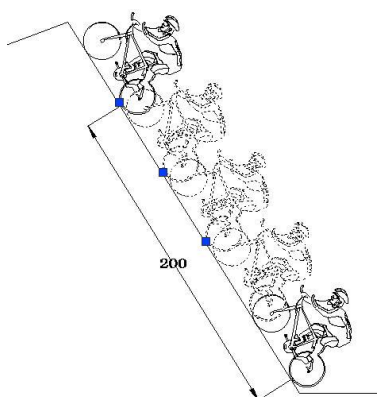

Measure

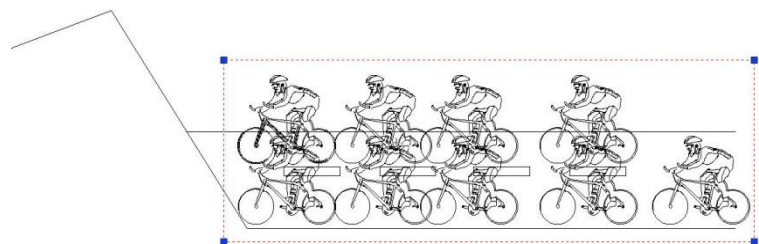

Array

**Statistics Summation:** This function sums up selected text or mtext. The selected text can not contain any other characters behind the number and the selected mtext can only contain a row of numerical values without blank spaces. Figures with prefix can also make statistics Summation and the system will summate them by different prefixes.

**Menu:** Express tools>Modify>Statistics Summation

**Command Entry:** KLL01

Start the command and the command line prompts as follow:

**Select objects:** Select Text or Mtext numerical value

In the Statistics dialog box, you can see the cumulative sum from the selected text numerical values. You can also re-select, replace, copy text numerical value again plus fill-in (show) the cumulative sum in any point of your current drawing.

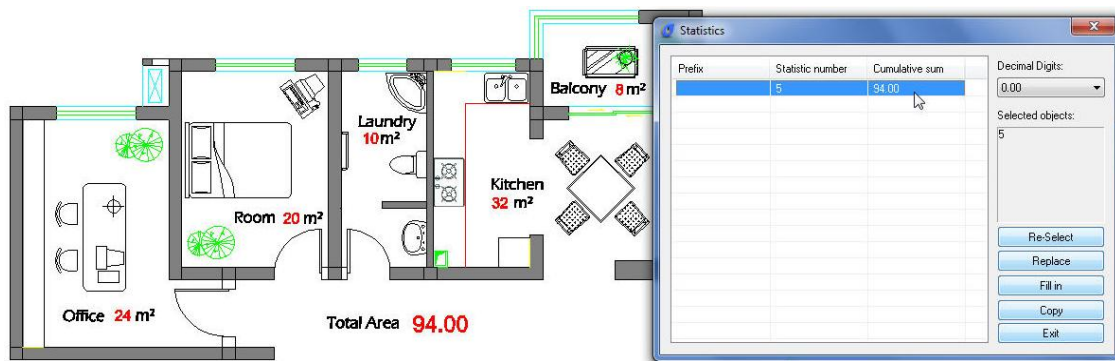
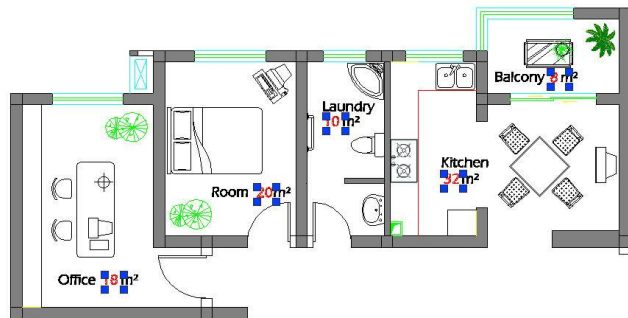

**Break Object:** In some industrial application design, sometimes we need to break pipes or cable lines in our schematic drawing to indicate their spatial relationship. Sometimes we also need to break lines at crossing point to make it convenient for the later edit. Break Object tool came from this kind of needs.

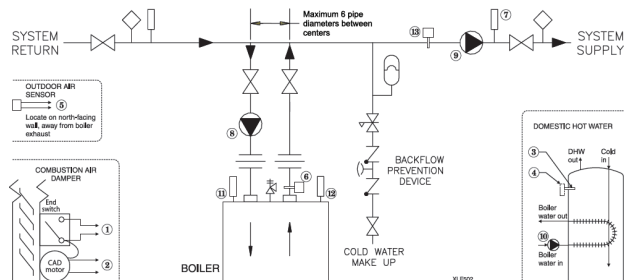

**Menu:** Express tools>Modify>Break Object

**Command Entry:** BREAKOBJECT

This tool provides four breaking modes with gap distance to visualize the differences between breaking options.

**Gap:** Indicates the gap value between broken objects

**Break all objects selected with each other:** This option breaks all intersected objects each other. You can select objects by window selection or picking each object.

**Break selected objects with other selected objects:** This option breaks all intersected objects by two selection sets (A and B). The objects selected under the first set (A) will be broken meanwhile the objects selected under the second set (B) will be not

broken.

*Break objects touching selected objects:* This option breaks all intersected objects that touch at first instance selected object.

*Break selected objects with any objects that touch it:* This option breaks the first instance selected object with all intersected objects to it.

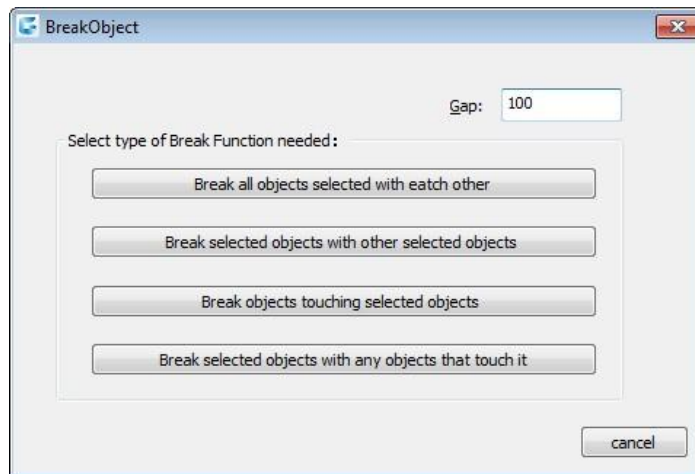

## Draw Tools

**Superhatch:** Fills an enclosed area or selected objects with a hatch pattern, solid fill or gradient hatch.

**Menu:** Express > Draw > Superhatch

**Command Entry:** Superhatch

The Superhatch dialog box is displayed:

**Image:** Accesses the Select Image dialog box to specify the image for the hatch pattern.

**Block:** Opens the Superhatch\_Insert dialog box to specify the block for the hatch pattern.

**Xref Attach:** Accesses the Select reference file dialog box for specifying an xref file for a hatch pattern.

**WipeOut:** Selects a wipeout object as a hatch pattern.

**Select Existing:** Selects an existing image, block, xref, or Wipeout as a hatch pattern.

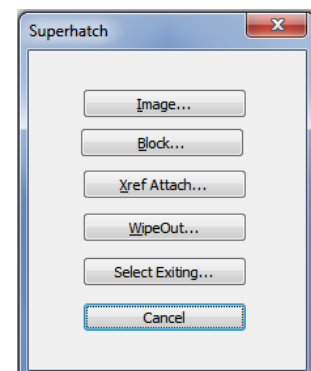

For Images:

1. Open Superhatch dialog box.
2. Click Image... button, choose an image file, the Superhatch Imageraster dialog box is displayed.
3. Pick the OK button in the Superhatch Imageraster dialog box, specify insertion point, scale factor and angle of rotation.
4. The prompt *"Is the placement of this IMAGE acceptable? [Yes/No] <yes> "*:
5. Pick a point in the rectangle, press ENTER to finish.

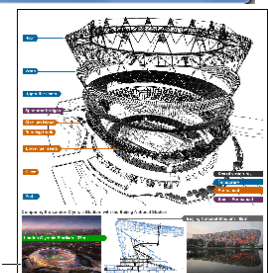
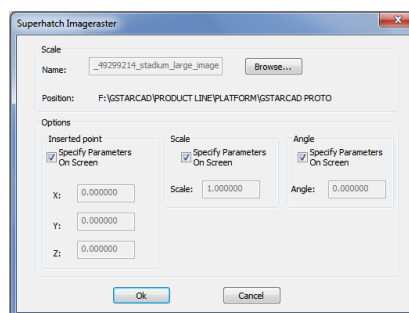

Is the placement of this IMAGE acceptable? [Y]

For Blocks:

1. Open Superhatch dialog box.
2. Click the Block... button to access the Superhatch\_Insert dialog box:

**Block:** Click the Block... button to select a block in the current file.

**File:** Pick the File... button to select a drawing file as the block

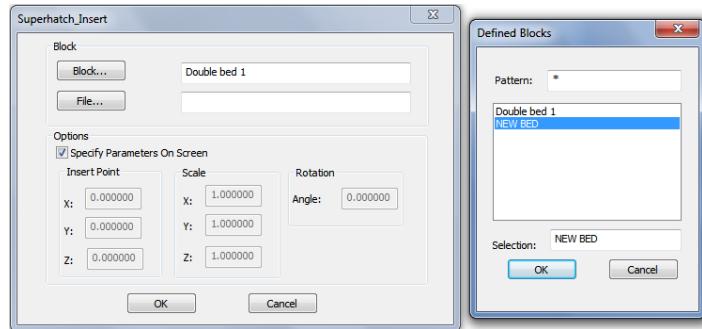

3. Select the block in the Defined Blocks dialog box and press OK.
4. Specify insertion point, scale factor and angle of rotation.
5. The prompt *“Is the placement of this IMAGE acceptable? [Yes/No] <yes>”* is displayed. Choose No to Esc. If you choose Yes, GstarCAD will ask you to specify the first point and the next point to place the image.
6. Specify an internal point of the objects for hatch boundary then press ENTER to finish hatch

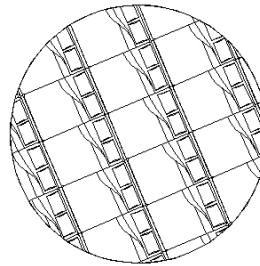

```

Command Line
Command: SUPERHATCH
Insert: Enter block name or [?] <NEW BED>: NEW BED
Unit: Millimeters convert: 1.0000
Specify insertion point or [Basepoint/Scale/X/Y/Z/Rotate]:
Enter X scale factor, specify opposite corner, or [Corner/XYZ] <1>: Enter Y scale factor <use X scale factor>:
Specify rotation angle <0>:
Specify insertion point:
Enter X scale factor <1.000000>:
please appoint the rotate angle:
Is the placement of this BLOCK acceptable? [Y]es/[N]o <Y>: Y
please appoint the first point:
Command:
    
```

For WipeOut:

1. Access Superhatch dialog box and click the Wipeout button:
2. GstarCAD will ask you to specify insertion point to create an area that masks underlying objects
3. Press ENTER to finish creating the boundary that masks underlying objects.

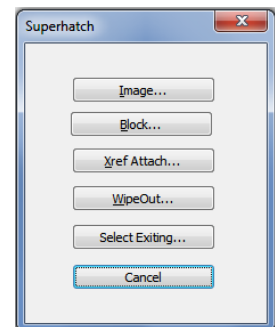
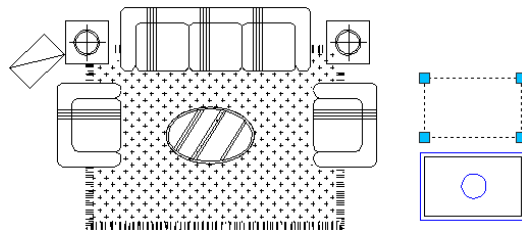

4. As shown in the picture, move the new block to the carpet, the block will automatically cover the object under it:

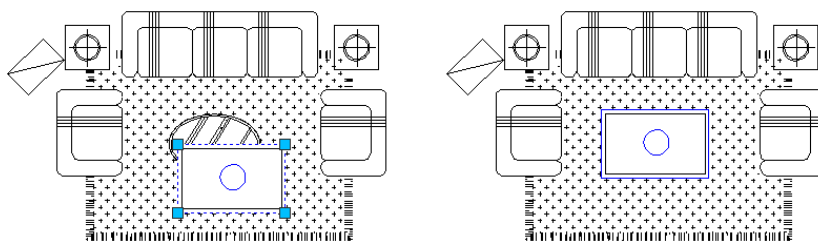

**Breakline Symbol:** Creates a polyline and inserts the breakline symbol. The options within this command are provided to control the relative size and appearance of the breakline symbol and an extension of the polyline beyond the selected start and end points.

**Menu:** Express tools>Draw>Breakline Symbol

**Command Entry:** BREAKLINE

Once start the command, the command line prompts as follow:

*Block = BRKLINE.DWG, Size = 1.000, Extension = 1.250 .  
Specify first point for breakline or [Block/Size/Extension/sSpecify line for breakline]:* Specify a point, or enter options

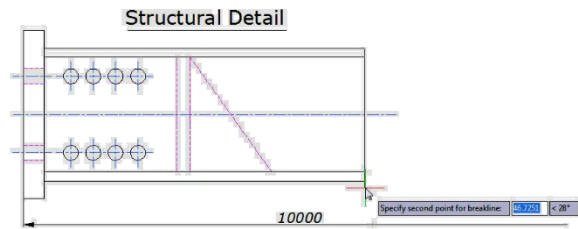

Options:

*Specify first point for breakline:* Draws break line through specifying its start point and end point.

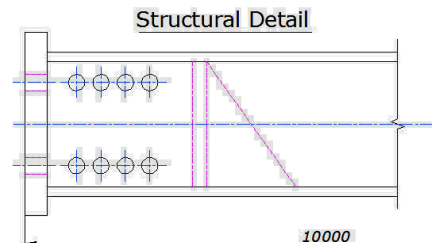

*Block:* Determines the block to be used as the breakline symbol.  
*Enter the block name for breakline symbol <BRKLINE.DWG>:*  
Enter a block name and press ENTER or press ENTER. If you press ENTER directly, the saving path of the break symbol file will be displayed on the command line.

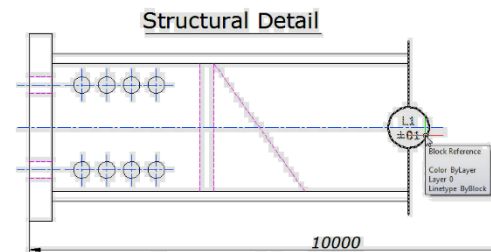

*Size:* Determines the size of the breakline symbol.  
*Breakline symbol size <1>:* Specify the size of the breakline symbol

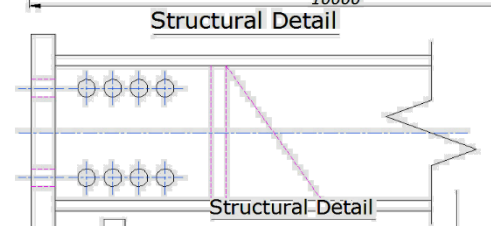

*Extension:* Determines the length of the line extension beyond selected points.

*Breakline extension distance <1.25>:* Specify the extension distance.

Once the start point for the break line or the setup break symbol is assigned, the command line prompts as follows:

*Specify second point for breakline:* Specify a point

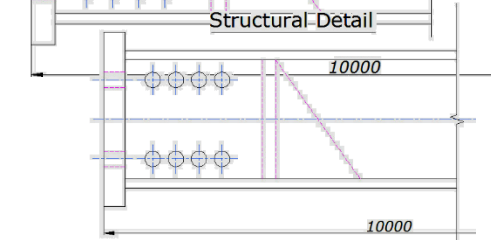

*Specify location for break symbol <Midpoint>:* Specify the point on the line segment to specify the location of the breakline symbol, or press ENTER to use the midpoint of the line.

### Pline Boolean:

**Menu:** Express>Draw>Pline Boolean

**Command Entry:** GC\_BooIOP

The Pline Boolean dialog box is displayed as shown in the following picture.

*Delete the entity chosen by second selection:* Choose whether to delete the second selected object. There are different Boolean operation options such as union, intersection and subtraction. After the operation the object will be a polyline.



**Operation case:** Here, we use two boolean operations as shown below to complete the design of mechanical parts.

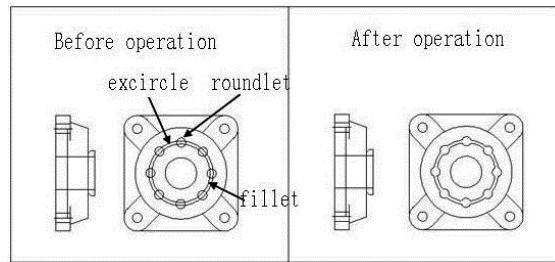

1. Start command, the dialog box will pop up;
2. Select the option "union" and uncheck the option "Delete the entity chosen by second selection", as shown below.

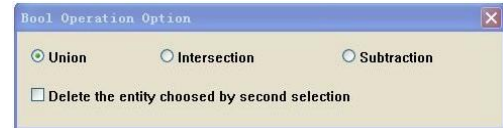

3. First select the exterior circle and then the small circles around it, it will keep all small circles around enabled for the next operation and you will get the first polyline as shown right side;

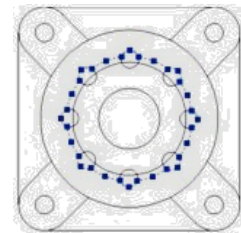

4. Start again the boolean operations, select option "subtraction" and check "Delete the entity chosen by second selection".

5. Then select the interior circle and then the small circles around it, then the small circles will be automatically deleted.

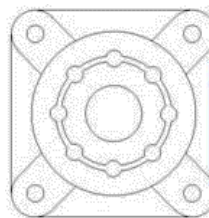

**Spline to Line:** Converts spline(s) to numbers of straight lines.

**Menu:** Express tools > Draw > Spline to Line

**Command Entry:** SPLINE2LINE

Once the command is started, the command line prompts as follow:

*Select spline or [Set parameters(S)]:* Select spline(s) or input "S" to set parameters

*[The line precision/Starting point (S) <1.00 >]:* Input a new value bigger than 0 to join precision between segment lines

*Conversion in a straight line to allow the greatest number of <5000 >]:* Input a new value smaller than 5000 to number of lines

At first, the system will fit the spline with a segment line which precision (Length) has been specified, if the line's number needed is more than the maximum number, the system will extend the length of the lines by force, using the maximum number of lines to fit the spline.

*Select spline or [Set parameters(S)]:* Then select the spline(s) to be converted and press Enter to finish the operation

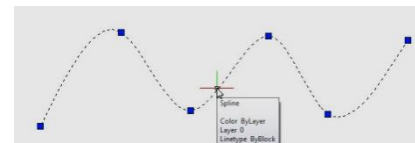
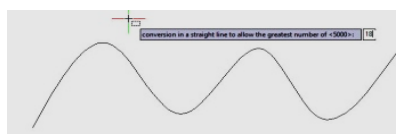
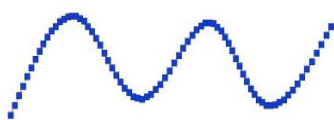



**Spline to Pline:** With this tool the Spline created can be converted to a polyline according to the accuracy (number of segments of the arc) that the user assigns. The more specified the segment number is, the higher is the matching degree between the converted Polyline.

**Menu:** Express tools>Draw>Spline to Pline      **Command Entry:** SPTPL

For example, draw the follow spline sample with 5 arcs as shown:

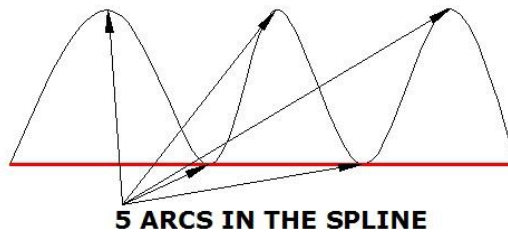

After the command SPTPL is started, *Please select the object* (Spline).  
 After selecting the object, a prompt message will be displayed > *Delete the spline? Yes(Y) / No(N)*: In this case, if we select Yes, this option will delete the spline in place but if we select No, it will keep the spline.  
 After inputting the delete spline option, a prompt message will be displayed > *Please enter the number of arcs Non-zero*: And we have to input a value higher than zero, for example 8. This value determines the segment number of arcs to be created in the new Polyline.

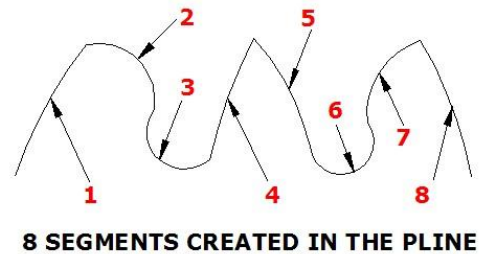

**Line to Pline:** This function can convert one or multiple connected straight line(s), arc(s) to one polyline. You can access from:

**Menu:** Express tools>Draw>Line to Polyline

**Command Entry:** Line2pl

After starting the command, a prompt message will be displayed>

*Please enter the join precision:* 0

The Join precision will determine the union space between end points of each object. In this case, we will input value 0 to ensure the connection between objects (lines).

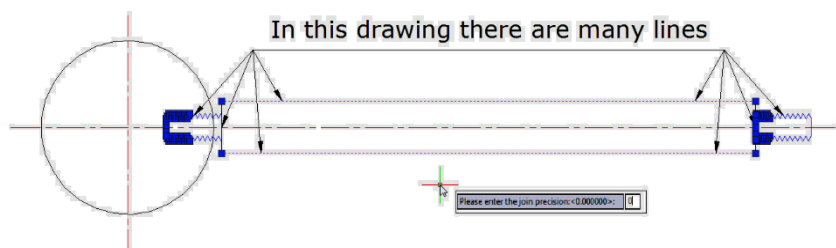

After inputting the join value, *Please select the objects to be joined* and converted to Polyline:

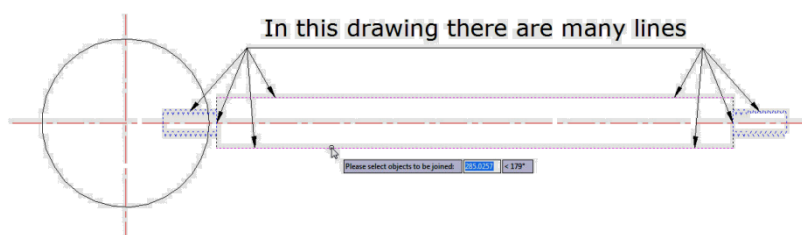



And finally, you have successfully created a polyline:

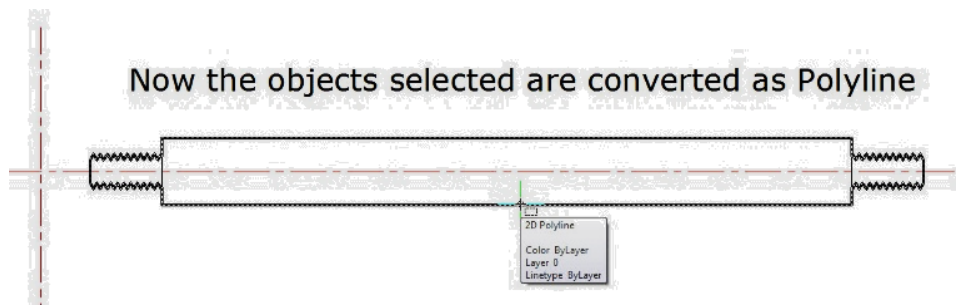

Now the objects selected are converted as Polyline

**Cloud Line:** Creates polyline objects comprised of arcs that resemble cloud lines.

**Menu:** Express tools>Draw>Cloud Line

**Command Entry:** REVCLLOUD

Once the command is started, the command line prompts as follow:

*Minimum arc length: Current Maximum arc length: Current Style: Normal*

*Specify start point or [Arc length/Object/Style] <Object>:* Specify a point or enter an option or press ENTER.

*Starting point:* Specifies the starting point of the cloud lines.

Guide crosshairs along cloud path...

Once the first arc links to the last arc, the prompts is displayed: *Reverse direction [Yes (Y)/No (N)]:* By inputting “Y”, all the arcs will change into an inverse position. By inputting “N”, the arcs will keep the current position.

*Arc:* Specifies the arc length.

*Specify minimum length of arc <current>:* Specify the arc length value or press ENTER.

*Specify the maximum arc length <current>:* Specify the arc length value or press ENTER.

Then specify start and end point to finish the operation.

**Note:** The maximum arc length should not be greater than 3 times the minimum arc length. The value of arc length is stored in the register.

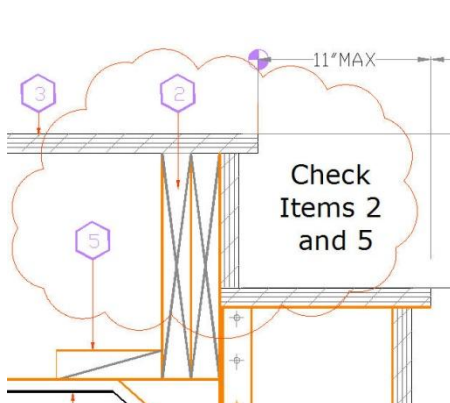
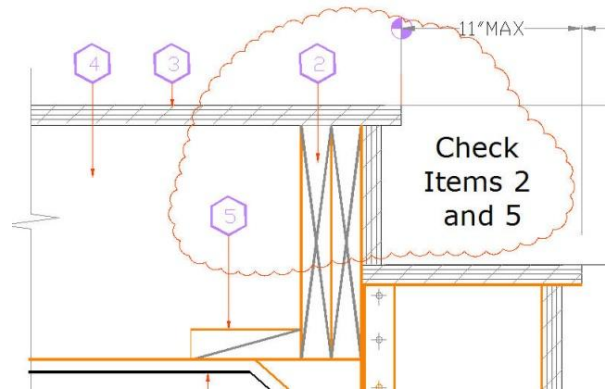

*Object:*  
Convert

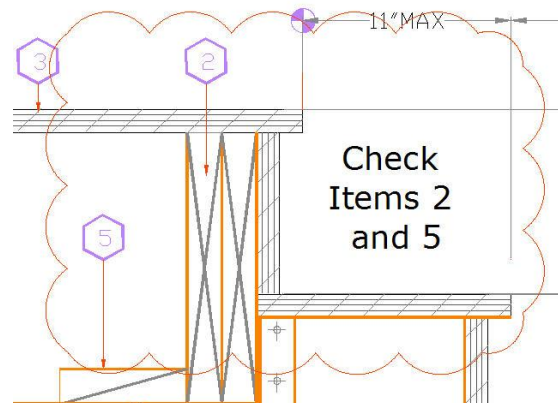

s the closed object to the cloud lines. It can only be applied to the closed object.

*Select objects:* Select a closed object(s)

*Reverse direction [Yes (Y)/No (N)]:* By inputting “Y”, all the arcs will change into an inverse position. By inputting “N”, the arcs will keep the current position. Select any option and press Enter to finish the operation.

*Style:* There are two styles: Normal (same as above) and Calligraphy, which makes the arcs of the cloud thicker than the normal one.

*Select arc style [Normal/Calligraphy] <Normal>:* Select Calligraphic

*Reverse direction [Yes (Y)/No (N)]:* By inputting “Y”, all the arcs will change into an inverse position. By inputting “N”, the arcs will keep the current position. Select any option and press Enter to finish the operation.

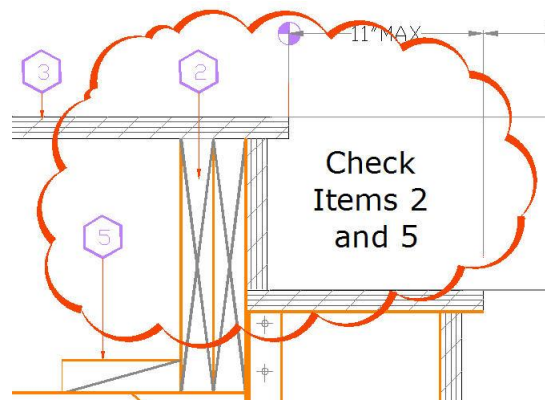
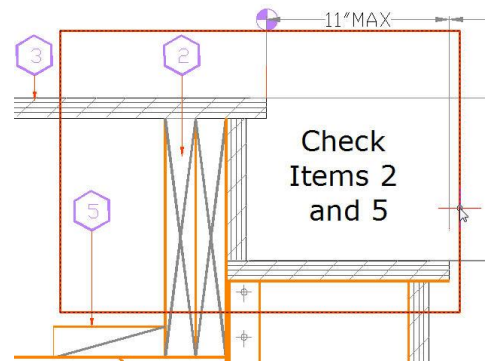

## Tools

**Command Alias:** This function allows users to add, modify, delete command alias and shell commands.

**Menu:** Express tools>Tools>Command Alias

**Command Entry:** ALIAS

Operation steps:

1. Start the command and a dialog box will pop up.
2. Select commands to be deleted and click “Remove” button to delete command alias.
3. Select the command to be modified and click “Edit” button, a dialog box will pop up.
4. Click “OK” to finish editing.

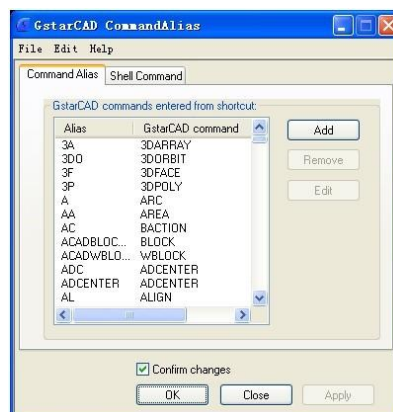

**System Variable Editor:** Allows you to view, save, load and compare system variable settings.

**Menu:** Express tools>Tools>System Variable Editor

**Command Entry:** SYSVDLG

System Variables Dialog Box Options:

**List Box:** Displays a list of system variables. The edit field above the list box allows for filtering the list box display based on user input. For example, entering DIM\* in the edit field filters the list to display only system variables that start with DIM. If nothing is entered in the edit field, the list displays all system variables. If more than one system variable is highlighted, all edit and display options are unavailable.

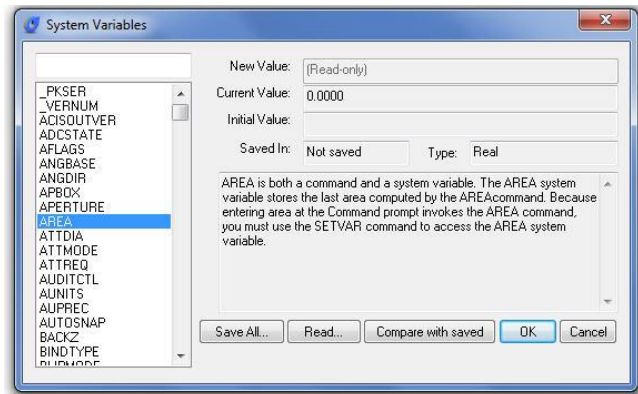

**New Value:** Displays the current value of the system variable highlighted in the list box and allows you to edit that value. No changes are committed until the dialog is closed with the OK button.

**Current Value:** Displays the value of the system variable highlighted in the list box as if SYSVDLG was started.

**Initial Value:** Displays the initial value of the system variable highlighted in the list box. This is the value the system variable has in a new drawing.

**Saved In:** Displays where the value of the highlighted system variable is saved.

**Type:** Displays the type of the highlighted system variable; for example, integer, real, string, and so on.

**Save All:** Saves the current system variable settings to an SVF or SCR file. SVF files can be read into SYSVDLG and SCR files are AutoCAD scripts that can be run from the AutoCAD command line. The button will display

Save All, Save Selected or Save Filtered depending on the condition of the system variable list.

**Read:** Restores saved settings from an SVF file. No changes are saved to the drawing until you choose OK. All pending changes can be discarded with the Cancel button. SYSVDLG will validate new system variable values as they are changed.

**Compare with saved:** Compares the variables of the drawing with the saved SCR file.

**Make Linetype:** Creates a linetype based on selected objects.

**Menu:** Express tools>Tools>Make Linetype

**Command Entry:** MKLTYPE

Once the command is started, the following window will be displayed. You can find the Line files (\*.lin) and apply them to the current drawing.

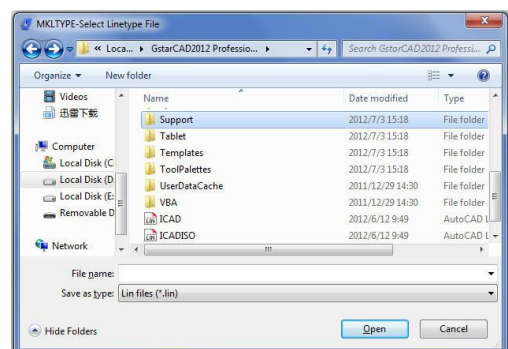

**Attach Xdata:** Attaches extended object data (xdata) to a selected object.

**Menu:** Express tools>Tools>Attach Xdata

**Command Entry:** XDATA

*Select object:* Use an object selection method.

*Input application name:* Specify application name.

*Enter an option [3Real/DIR/DISP/DIST/Hand/Int/Layer/Long/Pos/Real/Scale/STr/eXit] <eXit>:*

### Options:

*Application name:* An ASCII string up to 255 bytes long (group code 1000).

*3Real:* 3 real numbers (group code 1010).

*Dir:* A 3D World space direction (group code 1013).

*Disp:* A 3D World space displacement (group code 1012).

*Dist:* A distance (group code 1041).

*Hand:* An object handle (group code 1005).

*Int:* A 16-bit integer (group code 1070).

*Layer:* A layer name (group code 1003).

*Long:* A 32-bit signed long integer (group code 1071).

*Pos:* A 3D World space position (group code 1011).

*Real:* A real number (group code 1040).

*Scale:* A scale factor (group code 1042).

**List Object Xdata:** Lists the xdata associated with an object.

**Menu:** Express tools>Tools>List Object Xdata

**Command Entry:** XDLIST

*Select objects:* Use an object selection method.

*Input application name <\*>:* Specify an application name or press ENTER for all applications.

## Table Tools

**Table Fill In:** You can use this function to fill in the table or edit the texts.

**Menu:** Express>Table Tools>Table Fill In

**Command Entry:** FORMTXT

Operation steps:

1. Start the command.
2. Click in the cell or input "Q" and a dialog box will pop up.
3. In the dialog box you can set the text height fashion, just fashion and other text attributes.
4. Click the blank area of a cell and input texts directly.
5. Enter to finish filling in.

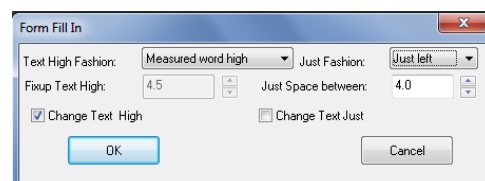

**Draw Table:** This function can help you draw a table.

**Menu:** Express>Table Tools> Draw Table

**Command Entry:** BGE

Operation steps:

1. Start the command.
2. Specify the first point of the table.
3. The command line prompts.
  - a. Press Q key and the width of the form will increase a little, is used to adjust the horizontal width.
  - b. Press W key and the width of the form will decrease a little, used to adjust the horizontal width.
  - c. Press A key and the height of the form will increase a little, used to adjust the vertical height.
  - d. Press S key and the height of the form will decrease a little, used to adjust the vertical height.
4. You can input the corresponding options to adjust the size of the table.
5. Specify the second point to finish drawing the table.

**Merge Cells:** This function is similar to merge cells in Excel.

**Menu:** Express>Table Tools>Merge Cells

**Command Entry:** BGH

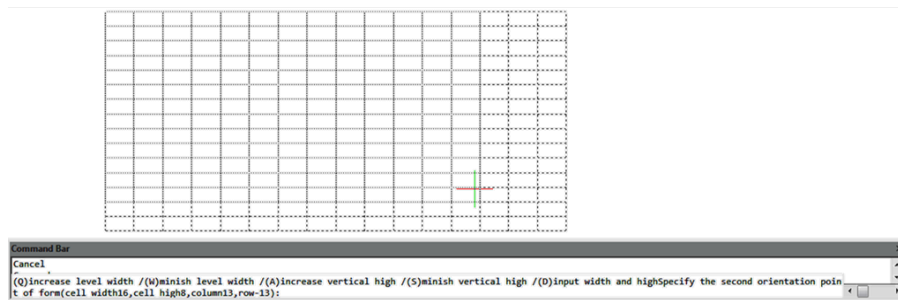

Operation steps:

1. Start the command.
2. Specify the borderline of the form to merge or the first cell, as shown below.
3. Merging effect as below. And press Enter to finish the command.

Sample1: Specify the borderline of the form

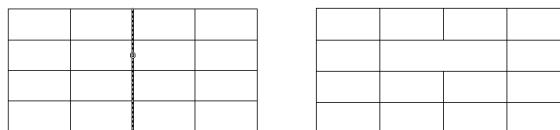

Sample2: Specify the first cell and another cell

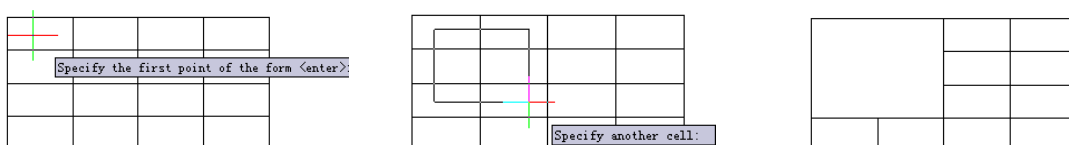

**Split Cells:** This function is similar to split cells in Excel.

**Menu:** Express>Table Tools>Split Cells

**Command Entry:** BGFG

Operation steps:

1. Start the command.
2. Specify the cell which needs to be split. (Fig14).
3. Move the cursor, when the rows and columns are a size up, click the mouse and the cell will be split automatically, (Fig15).

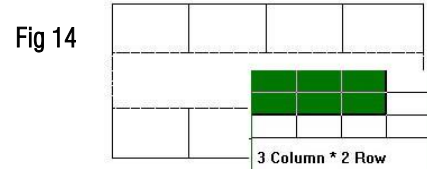

Fig 14

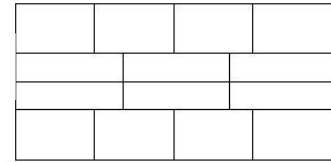

Fig 15

**Add Bias:** This function can add bias for a cell.

Click the start and end point according to the prompts and the system will provide an intersection snap and can easily find the start and end point of the bias, or you can click any area in one cell and the system will find the top left point of the cell automatically, then the system will prompt you to select the end point, you can also click any area in the cell, system will take the bottom right point as the end point automatically, this way, a bias is added in a cell.

**Menu:** Express>Table Tools>Add Bias

**Command Entry:** BGX

Operation steps:

1. Start the command.
2. Specify start point, you can click the top left point or click the blank area in the cell.
3. Specify end point to finish drawing the bias.

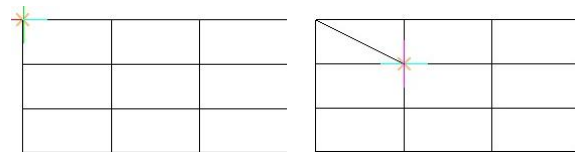

**Drag Multiple Lines:** You can change the row and column width by dragging the line of the table and the corresponding parts of the line will also change. For example, drag the line you selected to the right side and all the lines in the right side will move to the right side correspondingly.

**Menu:** Express>Table Tools>Drag Multiple Lines

**Command Entry:** BGMT

Operation steps:

1. Start the command.
2. Specify the line of table for dragging. (Fig16)
3. Specify the place or distance to drag to (left is positive). (Fig17)
4. Enter to finish moving. (Fig18)

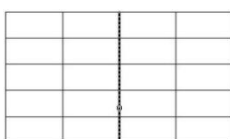

Fig 16

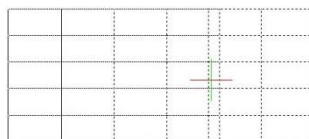

Fig 17

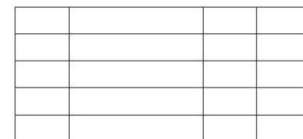

Fig 18

**Drag Line:** Different to Multiline drag, Drag line will just move the line you selected and other relevant lines will not move.

**Menu:** Express > Table Tools > Drag Line

**Command Entry:** BGST

Operation steps:

1. Start the command.
2. Specify the line of the table for dragging. (Fig19)
3. Specify the place or distance to drag to (left is positive). (Fig20)
4. Enter to finish the command. (Fig21)

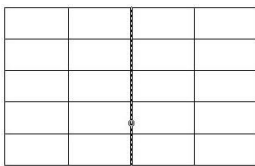

Fig 19

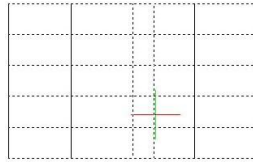

Fig 20

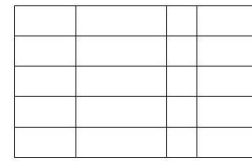

Fig 21

**Drag Segment:** This command will not change the lines of the whole table, but just move the side line of a cell.

**Menu:** Express > Table Tools > Drag Segment

**Command Entry:** BGJT

Operation steps:

1. Start the command.
2. Specify the line of the table for dragging (Fig22).
3. Specify the place or distance to drag (left is positive). (Fig23)
4. Enter to finish the command (Fig24).

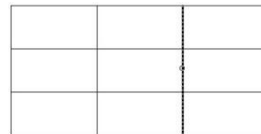

Fig 22

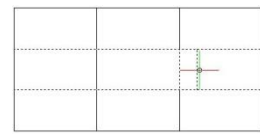

Fig 23



Fig 24

**Selection Scale:** This function can zoom in and zoom out the whole table base on the point you specified.

**Menu:** Express > Table Tools > Selection Scale

**Command Entry:** BGSF

Operation steps:

1. Start the command and specify the base point for the line of table. (Fig25)
2. Move the cursor and the table will zoom. (Fig26)
3. Drag to a suitable position and click. (Fig27)



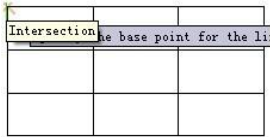

Fig 25



Fig 26



Fig 27

**Add Row:** This function can add rows to the table.

**Menu:** Express > Table Tools > Add Row

**Command Entry:** BGZH

Operation steps:

1. Start the command.
2. Specify the position of the new row.
3. The system will add a row below the point you specified.

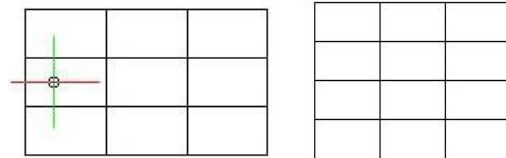

**Add Column:** This function can add new columns to the table.

**Menu:** Express > Table Tools > Add Column

**Command Entry:** BGZL

Operation steps:

1. Start the command.
2. Specify the direction of the new column.
3. The system will add a new column on the right side of the table.

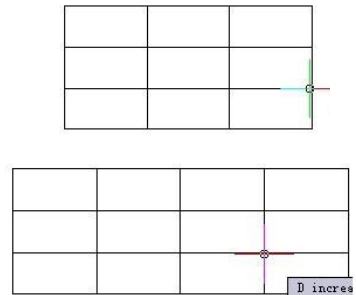

**Delete Row:** This function can delete the row of the table you specified.

**Menu:** Express > Table Tools > Delete Row

**Command Entry:** BGSB

Operation steps:

1. Start the command and specify the cell of row for delete.
2. The system will delete the row you specified.

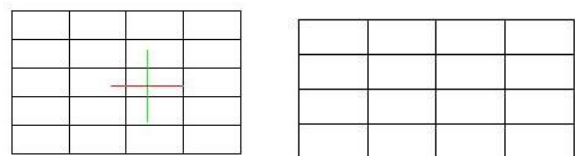

**Delete Column:** This function can delete columns you specified.

**Menu:** Express > Table Tools > Delete Column

**Command Entry:** BGSL

Operation steps:

1. Start the command.

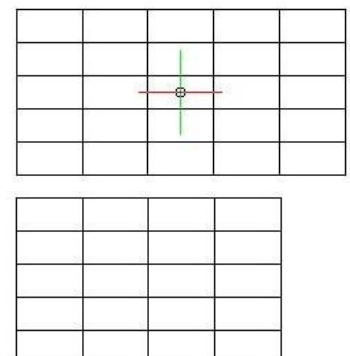

2. Specify the cell of column for delete.
3. The system will delete the column you specified.

**Delete Table:** This function can delete the table you selected.

**Menu:** Express>Table Tools>Delete Table

**Command Entry:** BGSC

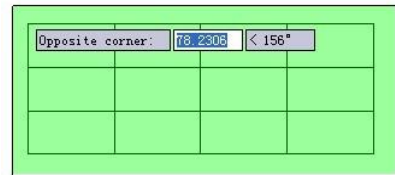

Operation steps:

1. Start the command and specify the table for delete.
2. Enter to finish deleting.

**Text Orientation Adjust:** This function is used to adjust the alignment of the texts.

**Menu:** Express>Table Tools>Text Orientation Adjust

**Command Entry:** BGJS

GstarCAD	GstarCAD	GstarCAD
GstarCAD	GstarCAD	GstarCAD
GstarCAD	GstarCAD	GstarCAD

Operation steps:

1. Start the command and select the text for adjust.
2. Press Enter and the command line will prompt the location mode.
3. Here we input "1" to select left alignment.
4. The text you specified will align to the left, as shown below.

```
Command Bar
Command: BGJS
*Text orientation adjust*=Bgjs
Select the text for adjust:
Select objects:Find out 1, total 1
Select objects:
Enter new justification...(0 Center,1 Left,2 Right,3 Both)<flush center>:
```

GstarCAD	GstarCAD	GstarCAD
GstarCAD	GstarCAD	GstarCAD
GstarCAD	GstarCAD	GstarCAD

**Notice:**

1. This function can only orient and adjust the table text in the TABLE layer.
2. The distance to the table line using left alignment or right alignment has already been set by the program, if you think that the distance is not suitable, you can use the GstarCAD command to adjust the distance.

**CAD Table to Excel:** This command will convert sheets, composed by line/Spline and text/Mtext in CAD, to EXCEL.

**Menu:** Express>Table Tools> CAD Table to Excel

**Command Entry:** GC\_CTE

Operation method:

1. Start the command and specify the conversion ratio.

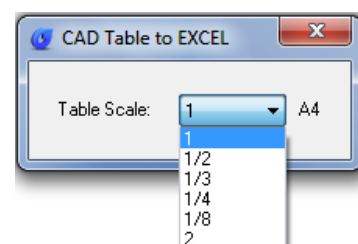

2. Select the table that need to be changed and press enter, the system will automatically open EXCEL after conversion.
3. Save the EXCEL sheet.

PART LIST						
11	BMW-C-11	SMALL BUSHINGS	3	STEEL		Welded ITEM 14
10	BMW-C-10	SHAFT	1	Q235A		
9	BMW-C-9	SUB - BASE PLATE	1	STEEL		16mm thickness
8	BMW-C-8	MULTI-HOLE BASE PLATE	1	STEEL		16mm thickness
7	BMW-C-7	THREADED SHAFT	1	Q235A		Welded ITEM 8
6	BMW-C-6	BUSHING "B"	2	Q235A		Welded ITEM 5
5	BMW-C-5	SUPPORT PLATE	1	STEEL		10.5mm thickness
4	BMW-C-4	BUSHING "A"	1	Q235A		Welded ITEM 5
3	BMW-C-3	BMW - THREADED PIN "B"	1	Q235A		M12 x 1.4 x 104
2	BMW-C-2	BMW - THREADED PIN "A"	1	Q235A		M10 x 2.0 x 100
1	BMW-C-1	TILT PLATE	1	STEEL		16mm thickness
ITEM NO	PART OR IDENTIFYING NO	NOMENCLATURE OR DESCRIPTION	QTY	MATERIAL	HEAT TREATMENT	REMARKS

PARTS LIST					
INIT	APPROVALS	DATE	INIT	APPROVALS	DATE
ARP	Alonso Pizzali	9/11			
<b>GSTARCAD</b>					
TITLE <b>BMW CHASSIS CLAMP ASSEMBLY</b>					
SIZE		CAGE CODE	DWG NO.	REV	
A2			BVM CP-10006394		
SCALE			SHEET		

PART LIST												
11	BMW-C-11	SMALL BUSHINGS	3	STEEL		Welded ITEM 14						
10	BMW-C-10	SHAFT	1	Q235A								
9	BMW-C-9	SUB - BASE PLATE	1	STEEL		16mm thickness						
8	BMW-C-8	MULTI-HOLE BASE PLATE	1	STEEL		16mm thickness						
7	BMW-C-7	THREADED SHAFT	1	Q235A		Welded ITEM 8						
6	BMW-C-6	BUSHING "B"	2	Q235A		Welded ITEM 5						
5	BMW-C-5	SUPPORT PLATE	1	STEEL		10.5mm thickness						
4	BMW-C-4	BUSHING "A"	1	Q235A		Welded ITEM 5						
3	BMW-C-3	BMW - THREADED PIN "B"	1	Q235A		M12 x 1.4 x 104						
2	BMW-C-2	BMW - THREADED PIN "A"	1	Q235A		M10 x 2.0 x 100						
1	BMW-C-1	TILT PLATE	1	STEEL		16mm thickness						
ITEM NO	PART OR IDENTIFYING NO	NOMENCLATURE OR DESCRIPTION	QTY	MATERIAL	HEAT TREATMENT	REMARKS						

PARTS LIST					
INIT	APPROVALS	DATE	INIT	APPROVALS	DATE
ARP	Alonso Pizzali	9/11			
<b>GSTARCAD</b>					
TITLE <b>BMW CHASSIS CLAMP ASSEMBLY</b>					
SIZE		CAGE CODE	DWG NO.	REV	
A2			BVM CP-10006394		
SCALE			SHEET		

## Coordinate Tools

**Export Coordinate:** It is easier to extract coordinate data from drawing with COEXPORT innovative tool.

**Menu:** Express > Coordinate Tools > Export Coordinate

**Command Entry:** DIMCOORD

You can pick as many points as you need from your drawing and export all the coordinate data to .txt or .xls file. This tool could be applied conveniently on planning, surveying, mapping, and construction drawings.

Execute COEXPORT command and select what format (.txt/.xls) you want to save the file. Then pick all the coordinate points on your current drawing. Each time you pick a point, its data will be automatically storage in the file you selected. To finish the process, press Enter. You can open the saved file and check out all coordinate data (X,Y,Z) extracted.

File name:	Coordinate Data Analysis
Save as type:	*.xls



	A	B	C
1	X	Y	Z
2	4166.793	3581.064	0
3	4176.993	3596.544	0
4	4196.193	3632.784	0
5	4221.512	3620.664	0
6	4216.473	3611.184	0
7	4241.552	3562.824	0
8	4244.793	3552.624	0
9	4100.673	3519.264	0
10	4067.073	3553.104	0
11	4033.953	3540.264	0
12	4018.713	3551.304	0
13	4111.473	3699.864	0
14	4129.713	3689.784	0

**Coordinate Point:** Dimensions the point coordinate in the drawing.

**Menu:** Express>Coordinate Tools>Coordinate Point

**Command Entry:** DIMCOORD

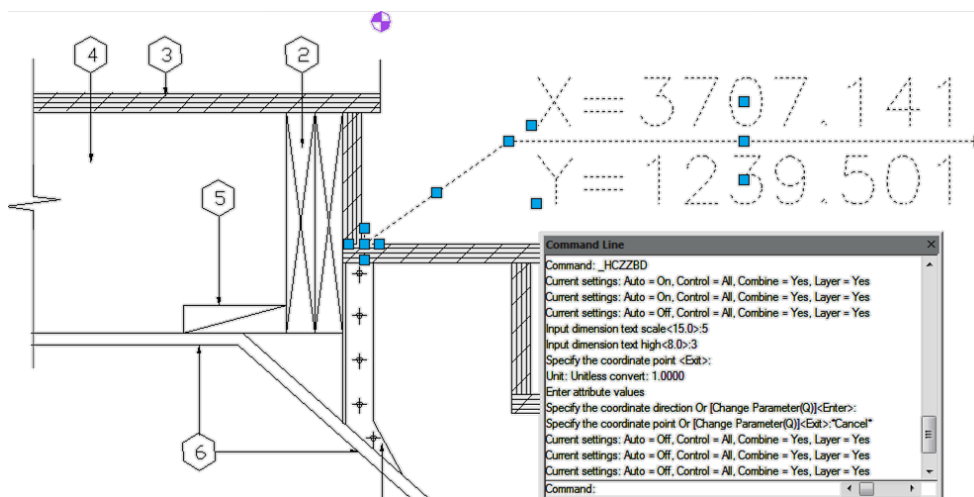

**Change Z Coordinate:** Choose several objects at one time and then change the Z coordinates together.

**Menu:** Express>Coordinate Tools>Change Z Coordinate

**Command Entry:** CHANGEZ

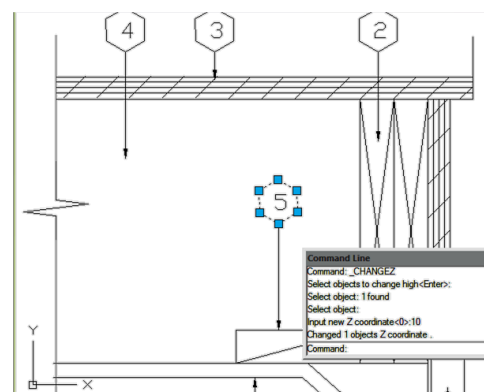

## Drawing Tools

**Drawing Lock:** Sometimes a designer sends drawings to other people, but doesn't want others to modify the drawings. The "Drawing Lock" function can turn the drawing into a whole block. You can't explode it or modify the objects of the original drawing. It is a good way to prevent others from modifying the drawing.

**Menu:** Express tools>Drawing Tools>Drawing Lock

**Command Entry:** LOCKUP

Once the command is started, the follow wizard will be displayed:

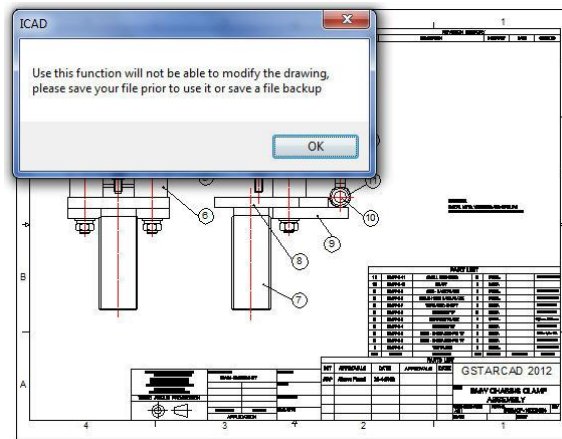

**Select objects:** Select all the objects in the current drawing to be locked and press Enter. **Note:** Please save your drawing before using this function, because the locked drawing can't be modified.

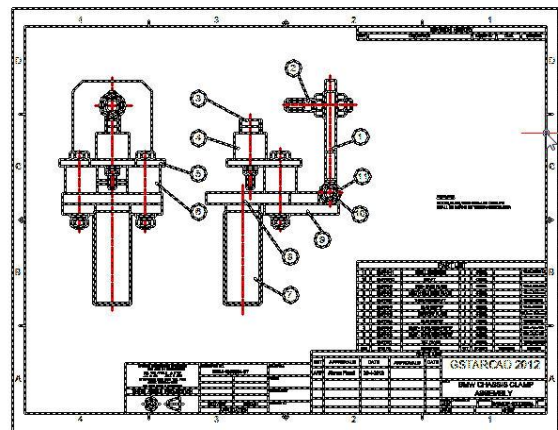
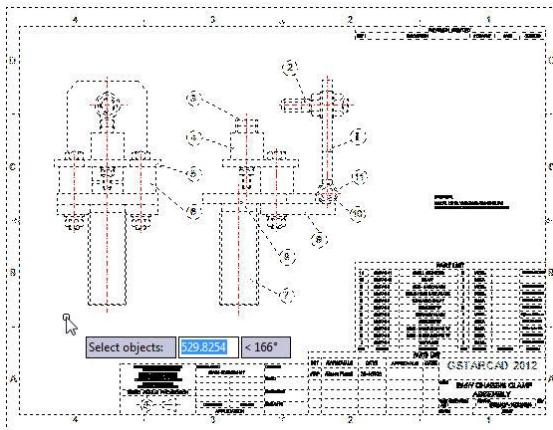

**Drawing Compare:** Drawing compare is an exclusive function in GstarCAD which is added according to the user's requirement. It enhances collaboration by using color-coded displays to show items on a drawing that have been changed, added, or deleted by other members of the design team. Changes to items such as styles, block attribute, object of block can also be tracked. The program will analyze the differences between two drawings automatically. Then the differences will be marked with different colors. Users can also set the marking color by clicking the "option" button.

**Menu:** Express tools>Drawing Tools>Drawing Compare

**Command Entry:** CMP

Once the command is started, the following window will be displayed:

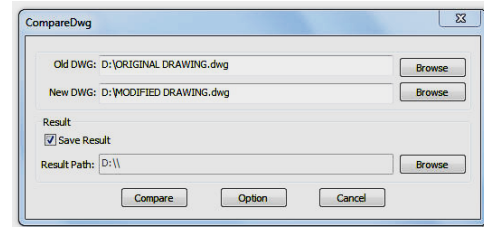

In this window, you have to browse the old DWG (original drawing) and the new DWG (drawing modified). You can also assign a path to save the compared drawing. Then select the button Option to set-up the comparison parameters.

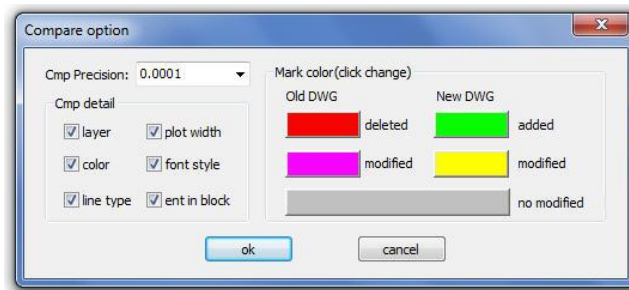

After setting up the comparison parameters such as: colors, layers, line type, etc. select Ok to confirm these parameters. Note: Pay attention to the mark color because the deleted, modified and added objects will assume these into the compared drawing. Then select the button Compare in the window below to compare both drawings.

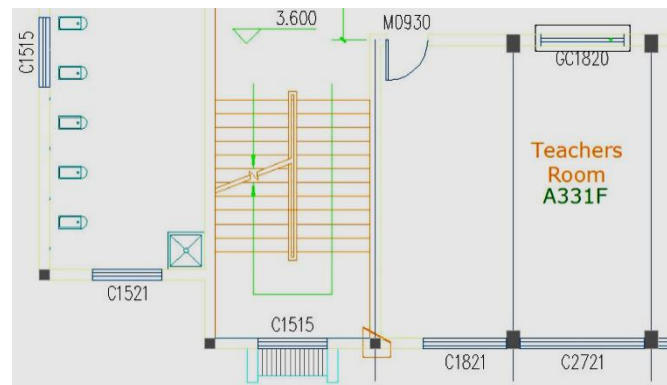
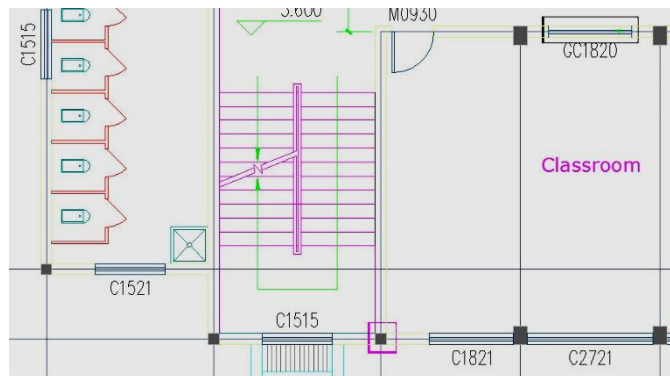
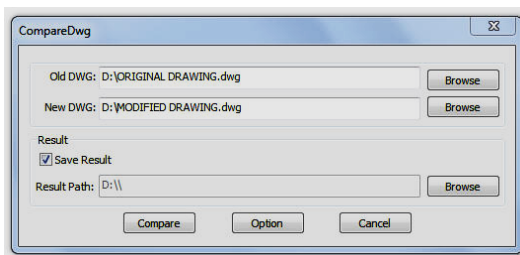



**Graphic Compare:** As we know the drawing compare function in GstarCAD can be used to compare similar drawings containing nearly number of drawn objects to each other, especially to compare different versions of revision drawings.

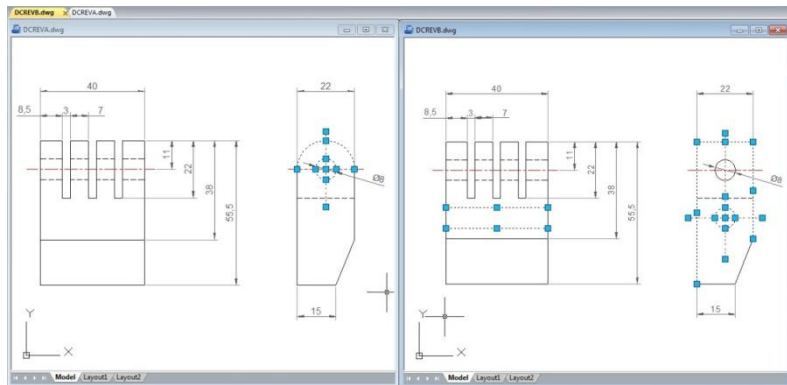

**Menu:** Express tools>Drawing Tools>Graphic Compare

**Command Entry:** OCOMP

Drawing compare can make comparisons between two similar drawings (old DWG and New DWG) and generate them as separate files. After pressing COMPARE button within CompareDwg dialog box, the program will generate and open `_old` and `_new`.dwg files, where you can see the differences between drawings.

Drawing Compare can find out differences (drawn objects) and show the result with different colors, e.g. if a line is modified, removed or newly drawn, it will be displayed in different colors.

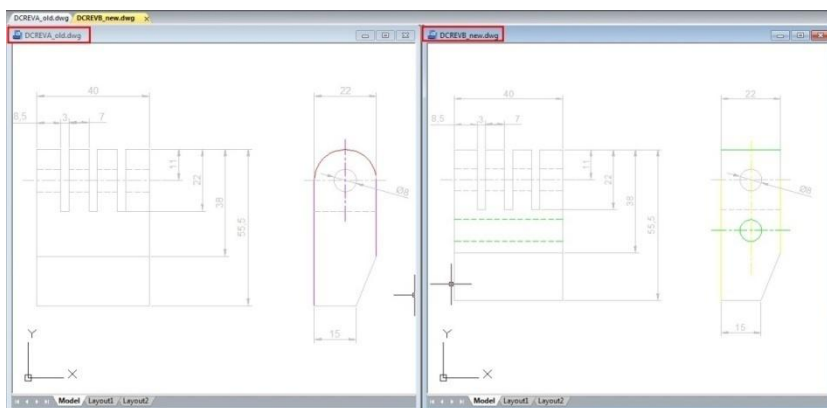
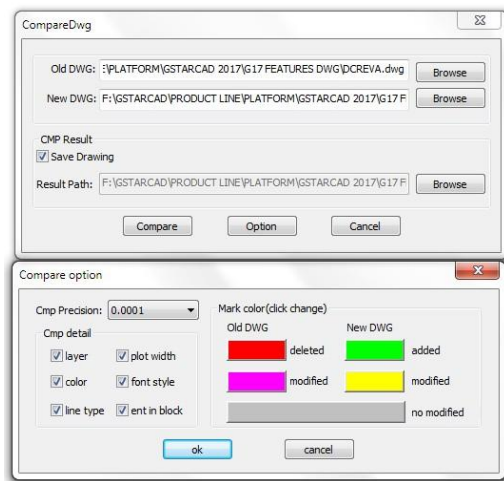

But there is something else that drawing compare could not accomplish so accurately. Drawing compare can't insert and show the compared objects on the current drawing working space that you are working at real time. Besides, drawing compare can't show the details of how the objects were located before they were modified.

So the details are very important when comparing objects. Now the new and innovative Graphic Compare tool can do more! It does not only compare two drawings with similar objects geometry and find out the differences but also display the details of any change at the current workspace of your

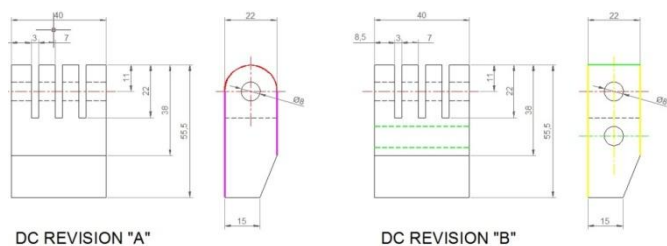



drawing in real time, e.g. if a line is modified, only the changed part of the line is displayed in different color. The unchanged part remains unchanged.

Graphic compare dialog box

You can invoke the Graphic Compare dialog box by typing OCOMP command at command line or by dynamic input.

*Specify Drawing:* Offer two options of drawing comparison between select objects on your current drawing or specify files.

*Select Objects:* Offers two options of objects selection including their base points to be compared.

*Select base objects and base point:* This option allows select all objects, including a basis point as a first selection set to be compared.

*Select compare objects and base point:* This option allows select all objects, including a basis point as a second selection set to be compared with the first selection set.

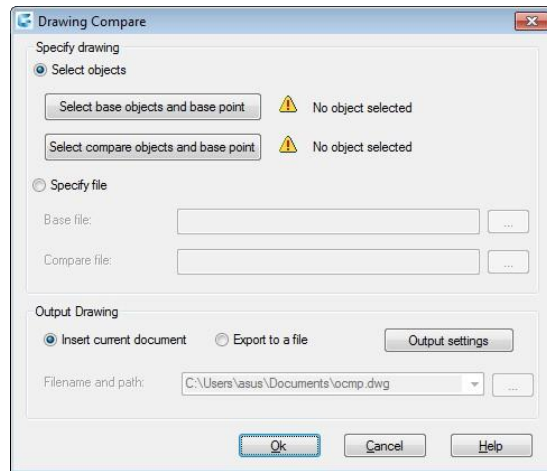

*Specify File:* Checking this option allows browse two drawing file to be compared known as base and compare file.

*Output Drawing:* Offers two options of drawing compared output.

*Insert current document:* This option allows insert the compared set of selected objects on the current workspace.

*Export to a file:* This option allows output the compared set of selected objects to a drawing file.

*Output settings:* You can setup properties like layer, color and linetype for all selected objects to be compared to enhance visual differences between them.

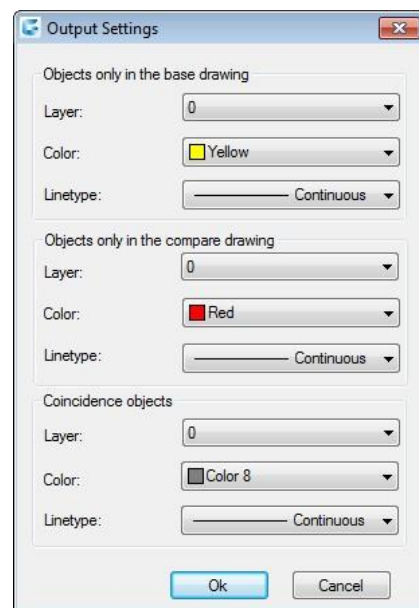

### Inserting Compared Objects Set into Current Drawing

To insert compared objects set into current drawing, first select the button *Select base objects and base point*. Then select all objects as first selection set called base objects and specify a base point for the base objects. Then select the button *Select compare objects and base point* and repeat all previous process mentioned above.

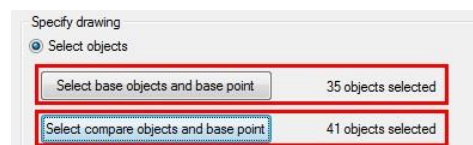

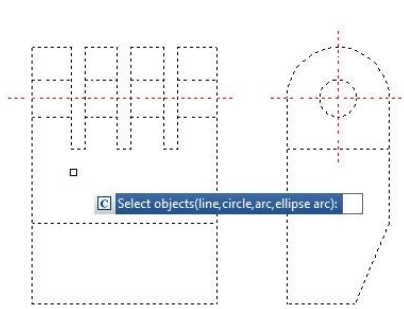

DC REVISION "A"

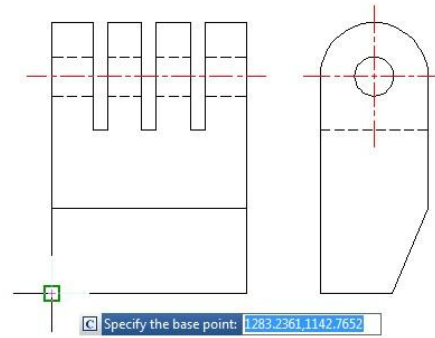

DC REVISION "A"

Under Output Drawing, check the option **Insert current document**. If you want setup visual properties for the compared objects, click Output settings button. After that you can place the compared objects set in a convenient point according your need.

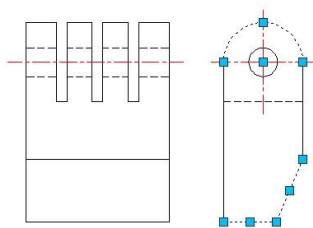
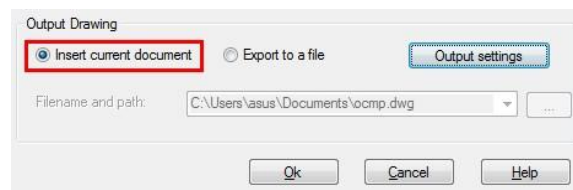

DC REVISION "A"

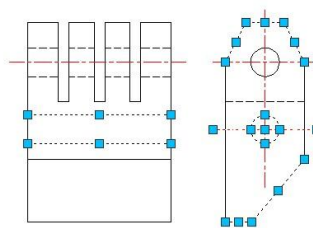

DC REVISION "B"

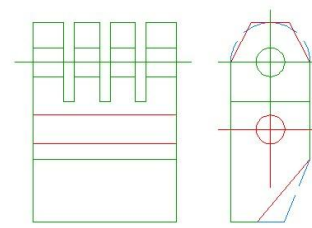

COMPARED

**Batch Purge (Batch Files Cleaning):** This new function allows to batch purge the excess objects such as blocks, layers, line type, dimension style or text style on several DWG files. The Batpurge tool doesn't need to open files. It executes the command of purge directly, which makes it run with very high efficiency. You can access it from:

**Menu:** Express>Drawing Tools> Batch Purge    **Command Entry:** Batpurge

After the command is started, a dialog box will be displayed. In this dialog box you can add, select, unselect, clean and start purging objects within DWG files with the following options:

**Add Files:** Add one or more batch files from the selected path.

**Add Folder:** Add DWG files from a selected folder.

**Select All:** Select all the DWG file lists at once.

**Select None:** Unselect all the DWG files at once.

**Delete:** Delete selected object(s) in the file list.

**Clear:** Clean all the DWG file lists at once.

**Start Purge:** Starts purging the selected DWG file list. After purging, GstarCAD will generate a notepad file where you can see the purge details.

**Log:** After the purge operation is finished, you can Login in to the created notepad file and see the batch purge detail record.

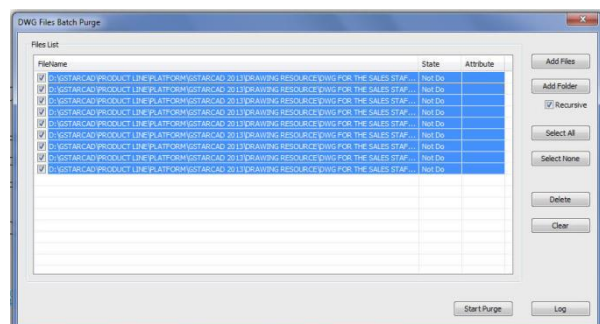

**AutoXLS Table Tools**

**Create Table:** Menu: Express tools>AutoXlsTable>Create Table    **Command Entry:** \_CAOT\_AUTOXLSTABLE\_CREATE

Operation steps:

1. In the AutoXLSTable pull-down menu, click Create Table.
2. Create an Excel spreadsheet or open an existing Excel spreadsheet in Excel.
3. Click Finish button in the AutoXlsTable pull-down menu in Excel.
4. Specify insertion point in GstarCAD.

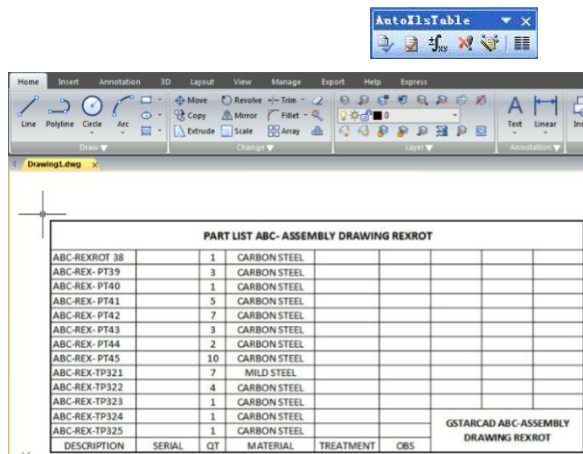
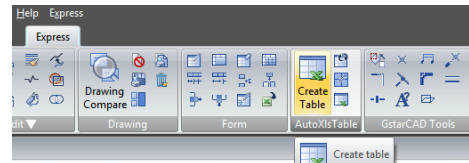

	A	B	C	D	E	F	G	H	I
1	PART LIST ABC- ASSEMBLY DRAWING REXROT								
2									
3	ABC-REXROT 38		1	CARBON STEEL					
4	ABC-REX- PT39		3	CARBON STEEL					
5	ABC-REX- PT40		1	CARBON STEEL					
6	ABC-REX- PT41		5	CARBON STEEL					
7	ABC-REX- PT42		7	CARBON STEEL					
8	ABC-REX- PT43		3	CARBON STEEL					
9	ABC-REX- PT44		2	CARBON STEEL					
10	ABC-REX- PT45		10	CARBON STEEL					
11	ABC-REX-TP321		7	MILD STEEL					
12	ABC-REX-TP322		4	CARBON STEEL					
13	ABC-REX-TP323		1	CARBON STEEL					
14	ABC-REX-TP324		1	CARBON STEEL					
15	ABC-REX-TP325		1	CARBON STEEL					
16	DESCRIPTION	SERIAL	QT	MATERIAL	TREATMENT	OBS			GSTARCAD ABC-ASSEMBLY DRAWING REXROT
17									

**Edit Table:** Menu: Express tools>AutoXlsTable>Edit Table Command Entry: \_CAOT\_AUTOXLSTABLE\_EDIT

Operation steps:

1. Click Edit Table.
2. Select a table created by AutoXlsTable in GstarCAD then the Excel file will open.

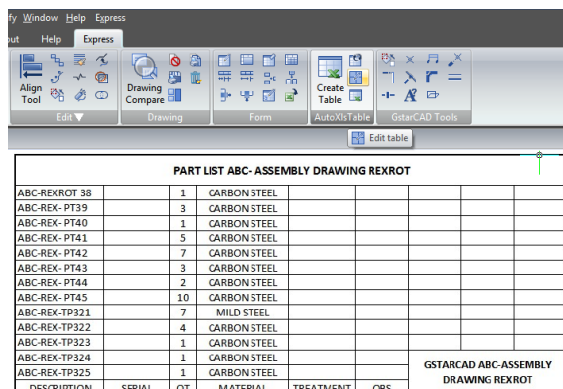
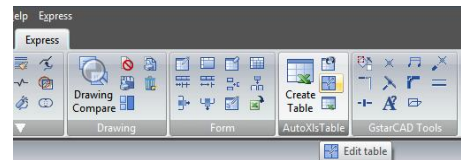

	A	B	C	D	E	F	G	H	I
1	PART LIST ABC- ASSEMBLY DRAWING REXROT								
2									
3	ABC-REXROT 38		1	MILD STEEL					
4	ABC-REX- PT39		3	MILD STEEL					
5	ABC-REX- PT40		1	MILD STEEL					
6	ABC-REX- PT41		5	MILD STEEL					
7	ABC-REX- PT42		7	MILD STEEL					
8	ABC-REX- PT43		3	MILD STEEL					
9	ABC-REX- PT44		2	MILD STEEL					
10	ABC-REX- PT45		10	MILD STEEL					
11	ABC-REX-TP321		7	MILD STEEL					
12	ABC-REX-TP322		4	MILD STEEL					
13	ABC-REX-TP323		1	MILD STEEL					
14	ABC-REX-TP324		1	MILD STEEL					
15	ABC-REX-TP325		1	MILD STEEL					
16	DESCRIPTION	SERIAL	QT	MATERIAL	TREATMENT	OBS			GSTARCAD ABC-ASSEMBLY DRAWING REXROT

**Update Table:** Update table whose original Excel spreadsheet was modified.

**Menu:** Express tools>AutoXIsTable>Update Table

**Command Entry:** \_CAOT\_AUTOXLSTABLE\_UPDATETBL

Operation steps:

1. Click Update table.
2. Select the table to update then the table will update automatically according to the relevant Excel.

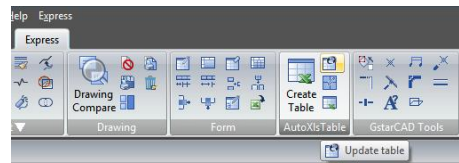

	A	B	C	D	E	F	G	H	I
1	PART LIST ABC- ASSEMBLY DRAWING REXROT								
2									
3	ABC-REXROT 38		1	MILD STEEL					
4	ABC-REX- PT39		3	MILD STEEL					
5	ABC-REX- PT40		1	MILD STEEL					
6	ABC-REX- PT41		5	MILD STEEL					
7	ABC-REX- PT42		7	MILD STEEL					
8	ABC-REX- PT43		3	MILD STEEL					
9	ABC-REX- PT44		2	MILD STEEL					
10	ABC-REX- PT45		10	MILD STEEL					
11	ABC-REX-TP321		7	MILD STEEL					
12	ABC-REX-TP322		4	MILD STEEL					
13	ABC-REX-TP323		1	MILD STEEL					
14	ABC-REX-TP324		1	MILD STEEL					
15	ABC-REX-TP325		1	MILD STEEL					
16	DESCRIPTION	SERIAL	QT	MATERIAL	TREATMENT	OBS	GSTARCAD ABC-ASSEMBLY DRAWING REXROT		

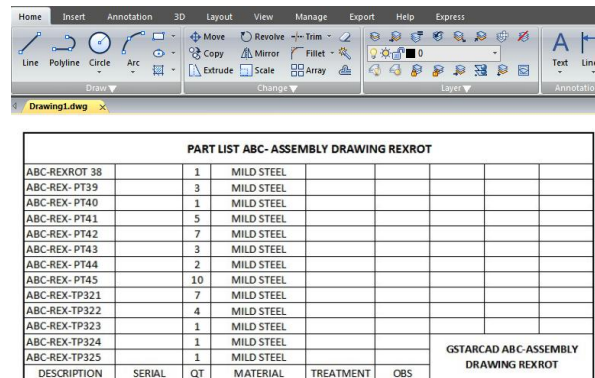

**Update All the Tables:**

**Menu:** Express>AutoXIsTable>Update All the Tables Command

**Entry:** CAOT\_AUTOXLSTABLE\_UPDATEALLTBL

After executing this command, the system will update all the table objects created by “Create Table” command.

**File Link Management:** You can use this function to edit, manage the link relation between a table object and an external EXCEL file.

**Menu:** Express>AutoXIsTable>File Link Management

**Command Entry:** CAOT\_AUTOXLSTABLE\_MANAGELINK

Operation steps:

1. Start the command.
2. Select table object in the drawing and a dialog box will pop up.
3. Click the “ Browse” button to open the file selection dialog box.
4. Select an XLS file which needs to be connected with a table object and click “OK”, then return to the Link Manager dialog box.
5. You can use the “Attach”, “Delete” and “Update” button to complete link related editing and management.

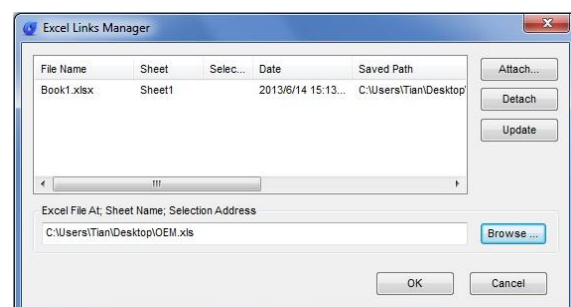

**Path Settings:** This function is used to set the path of an Excel file.

**Menu:** Express>AutoXlsTable>Path Settings

**Command Entry:** CAOT\_AUTOXLSTABLE\_USINGPATH

Operation steps:

1. Start the command and a dialog box will pop up as below.
2. In the dialog box, you can set the path pattern of the Excel file.

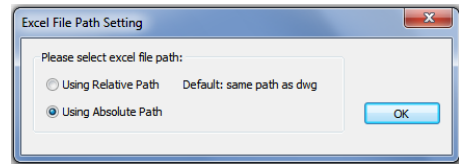

**Selection Management:** You can use this function to calculate objects length and area, when the length and area change, the calculating data will update automatically.

**Menu:** Express>AutoXlsTable>Selection Management

**Command Entry:** CAOT\_AUTOXLSTABLE\_SELECTION

Purpose: use the “Selection Management” function to calculate the area of a circle and a rectangle, when length and area change, the calculating data will update automatically.

1. Draw a circle and a rectangle as below, use the “Create Table” function to create a table as below.

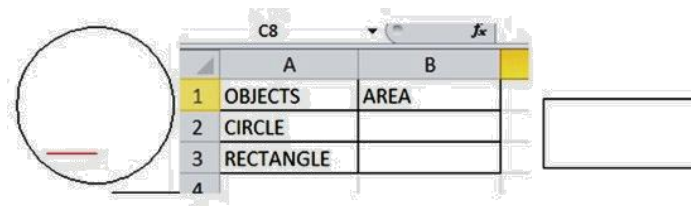

2. Start the “Selection Management” command and a dialog box will pop up.
3. Input “CIRCLE” and click the “New Group” button.
4. Select the circle.
5. Press enter, the “Selection Management” dialog box will add a new item “CIRCLE”, as shown below.
6. You can add a “RECTANGLE” item using the same operation as above.
7. Click “Close” to exit “Selection Management”.
8. Use the “Edit Table” command to edit the table.
9. Click the cell on the right side of “CIRCLE” and click the “Insert Function” icon, as shown below:
10. In the dialog box, you can specify the entity as “CIRCLE”, Layer as “All” and click “OK”.

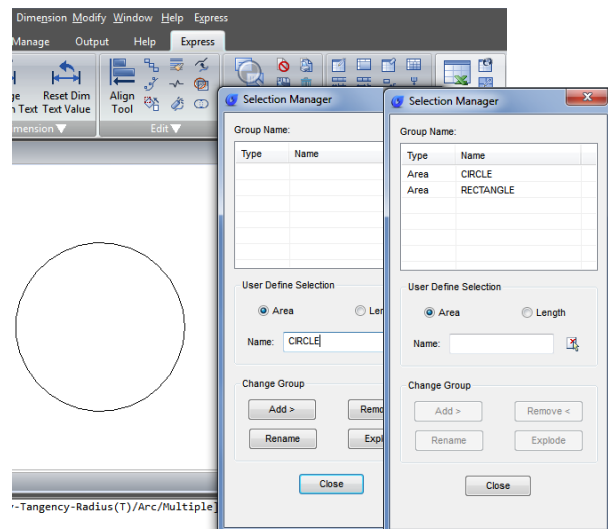

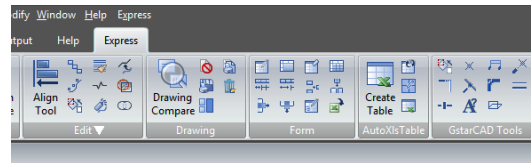
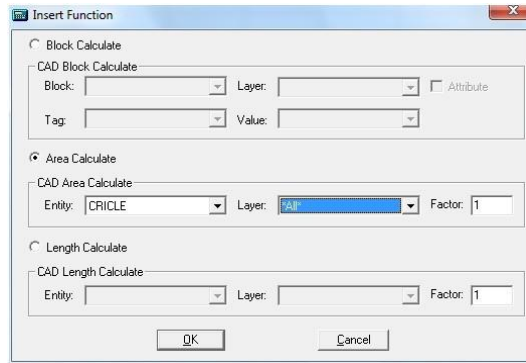
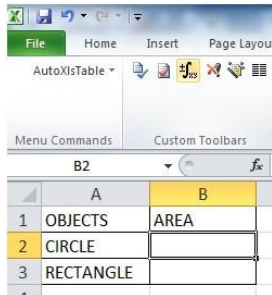

11. Use the same operation to insert the rectangle area calculating function. Then Click the pull-down menu “Finish” option of AutoXisTable as shown.
12. Back to CAD and the table will calculate the area of the circle and rectangle.
13. Scale the rectangle and the table data will change automatically.

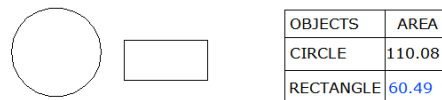

**GstarCAD Tools**

**Drawing Scale:** You can set the drawing scale before drawing, when you are using other tools (for example “Line Such as Chord” and “Modify Line width”), our software will adjust the scale automatically.

**Menu:** Express>GstarCAD Tools>Drawing Scale

**Command Entry:** SASCL

Operation steps:

1. Start the command.
2. Input a drawing ratio and enter to finish.

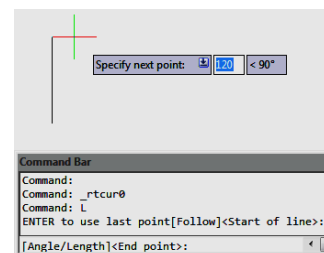



**Rotate Cursor:** The cursor can rotate anti-clockwise by 0 degree or 45 degree.

**Menu:** Express>GstarCAD Tools>Rotate Cursor>0 or 45

**Command Entry:** RTCUR0/RTCUR45

**Side Line: Menu:** Express>GstarCAD Tools>Rotate Cursor>Side Line

**Command Entry:** RTCUR1

Operation steps:

1. Start the command.
2. Select the reference segment and system will align the X axis of the cursor to the selected segment.

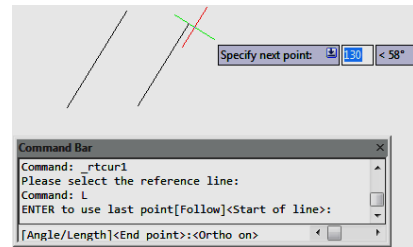

**Real Time Rotate:**

**Menu:** Express>GstarCAD Tools>Rotate Cursor>Real Time Rotate

**Command Entry:** RTCUR

Operation steps:

1. After executing the command, the command line prompts as below.
2. You can use the AWSD four keys to control the cursor direction until you are satisfied and press enter.



**Draw Axonometric Line:** Using this function can easily draw an axonometric drawing.

**Menu:** Express>GstarCAD Tools>Draw Axonometric Line

**Command Entry:** SALPL

Operation steps:

1. Start the command and input the line width value.
2. The command line will prompt as below, input corresponding options, you can use it to switch between 0 degree and 45 degree and you can also input any angle value. Then press Enter to finish the command.

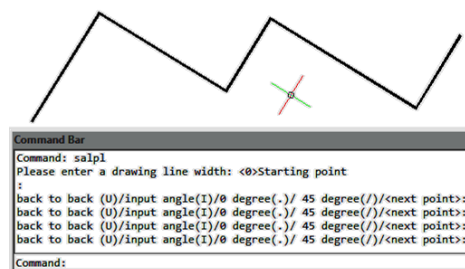



## GstarCAD Express Tools

**Visual Extension:** Normally after extension, the extension effect will be displayed, but Visual Extension can display the effect in real time until you confirm the position.

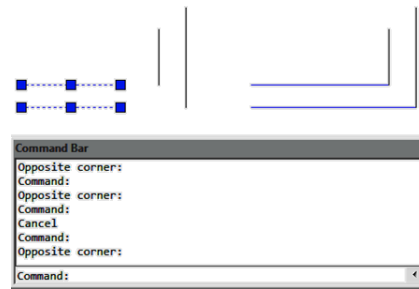

**Menu:** Express>GstarCAD Tools>Visual Extension

**Command Entry:** ETT

Operation steps:

1. Start the command.
2. Select the line that needs to be extended, the system will choose the nearest side you clicked as extension side automatically.
3. Move the cursor and the segment will extend in real time.

**Normal Connect:** The Normal Connect function is similar to zero distance chamfer, it can delete the lines of actual intersection or apparent intersection parts.

**Menu:** Express>GstarCAD Tools>Normal Connect

**Command Entry:** GXFILT

Operation steps:

1. Start the command.
2. Select the first line segment.
3. Select the second line.
4. The result will be as shown in the picture.

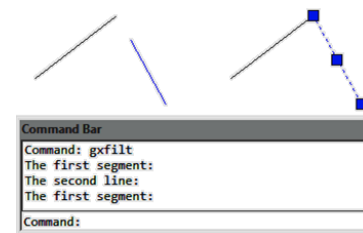

**Flex Connect:** This function can extend or cut down the line to the actual intersection or apparent intersection point.

**Menu:** Express>GstarCAD Tools>Flex Connect

**Command Entry:** GXFSS

Operation sample:

1. Start the command.
2. Select the elongation (or shortening) of the line.

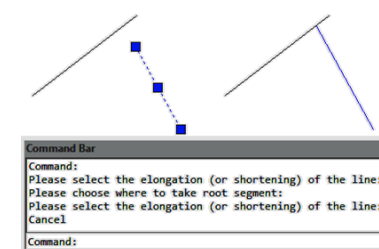

**Super Fillet:** This function can not only do the fillet operation but can also unify the filleted line layer, color and line type and the unified standard will take the first selected fillet object as reference.

**Menu:** Express>GstarCAD Tools>Super Fillet

**Command Entry:** SFILLET

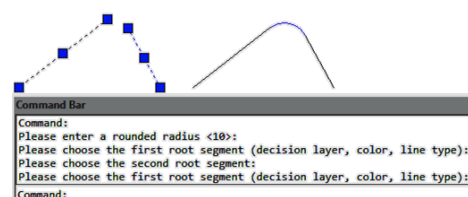

## GstarCAD Express Tools

Operation steps:

1. Start the command and input fillet radius.
2. Choose the first segment, as shown below. After executing the command, the layer, color, line type of another line and fillet will match with the first segment.
3. Choose the second segment.

**Modify Linewidth:** Modify the line width you specified, if what you specified is a line and our software will convert the line to Pline automatically and change the line width. This function is similar to the pedit function, we can use it as a shortcut version and it is very convenient for modifying the line width.

**Menu:** Express>GstarCAD Tools>Modify Linewidth

**Command Entry:** LCW

Operation steps:

1. Start the command.
2. Select the line.
3. Enter a new line width value and here we input "2" for example.
4. Enter to finish and the effect will be as shown in the picture.

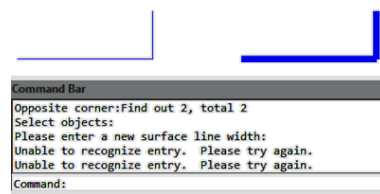

**Cross to Break:** In engineering drawings, many places need to break the cross line. If we do this the original way, it will be very complex. Using this function breaking lines can be easily done.

**Menu:** Express>GstarCAD Tools>Cross to Break

**Command Entry:** CBK

Operation steps:

1. Start the command.
2. Specify the occluded line.
3. Choose the occluded (to be disconnected) line and what you selected will be cut off automatically.
4. Enter to finish the command.

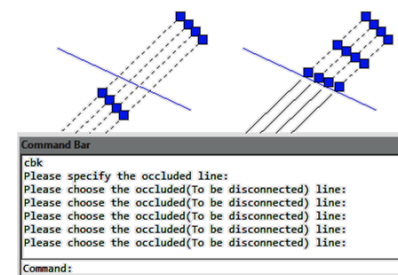

**Control Break Width:** This function is used to set break width for Cross objects.

**Menu:** Express>GstarCAD Tools>Control Break Width

**Command Entry:** CBKWID

Operation steps:

1. Start the command.
2. Enter the width of the break space.

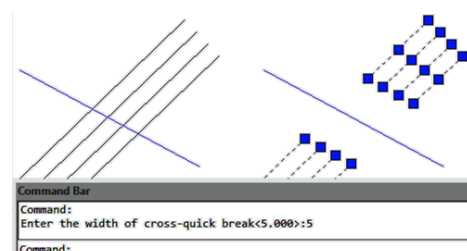

**Modify Text:** In here you can find several tools to modify text properties.

**Text Height:**

**Menu:** Express tools>GstarCAD Tools>Modify Text>Text Height

**Command Entry:** TXT40

1. Start the command.
2. Select a single line text.
3. Input text height.
4. Press enter to finish the command.

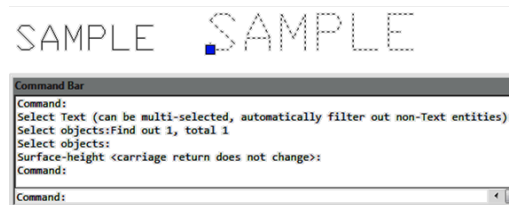

**Width Factor:**

**Menu:** Express tools>GstarCAD Tools>Modify Text>Width Factor

**Command Entry:** TXT41

1. Start the command.
2. Select a single line text.
3. Input Width height ratio.
4. Press enter to finish the command.

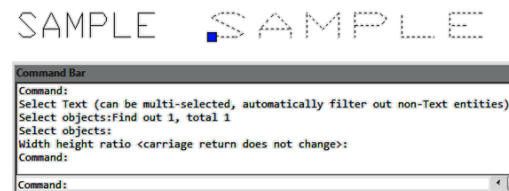

**Angle:**

**Menu:** Express tools>GstarCAD Tools>Modify Text>Angle

**Command Entry:** TXT50

1. Start the command.
2. Select a single line text.
3. Input rotation angle.
4. Press enter to finish the command.

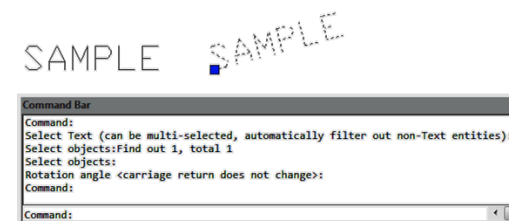

**Obliquing Angle:** Different to the rotation angle, after executing the command, the text will get an inclination deformation effect.

**Menu:** Express tools>GstarCAD Tools>Modify Text>Obliquing Angle

**Command Entry:** TXT51

1. Start the command.
2. Select a single line text.
3. Input tilt angle.
4. Press enter to finish the command.

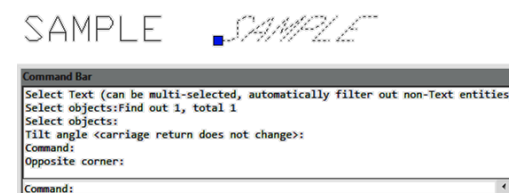

## GstarCAD Express Tools

---

**Options Modify:** You can use this function to modify all the options above.

**Menu:** Express tools>GstarCAD Tools>Modify Text>Options Modify

**Command Entry:** EDTXT

**Super Axonometric:** It is a quintessential function that can easily convert a plan drawing to an axonometric drawing.

**Menu:** Express>GstarCAD Tools>Super Axonometric

**Command Entry:** ZC

Operation steps:

- 1.Start the command.
- 2.Select objects and press enter, as shown below.
- 3.Enter the axonometric point of view, such as 45 degree.
- 4.The effect will be as below.

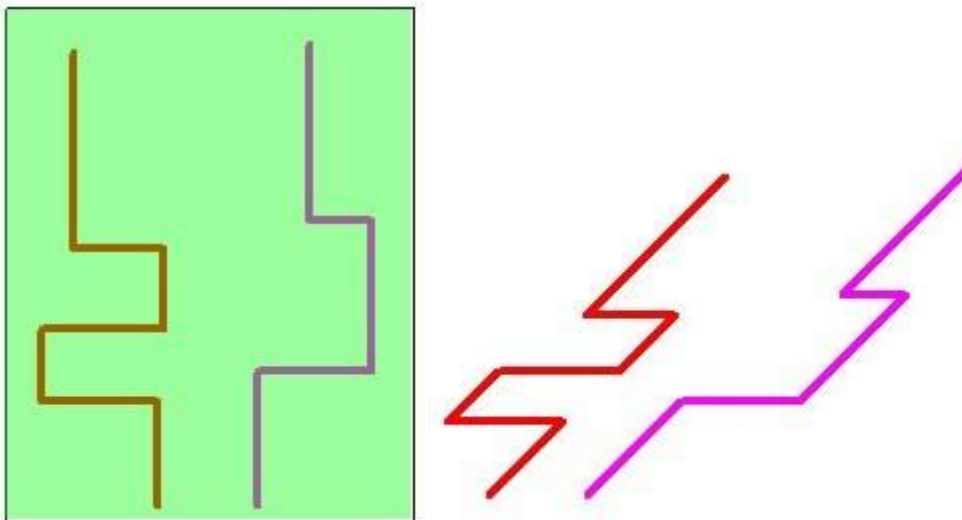

## Print Tools

**Print PLT:** Users can send PLT files to printer for printing.

**Menu:** Express tools>Plot Tool>Print PLT

**Command Entry:** PrintPlt

Operation Steps:

1. Start the command.
2. Select PrintPlt.exe in the dialog box.

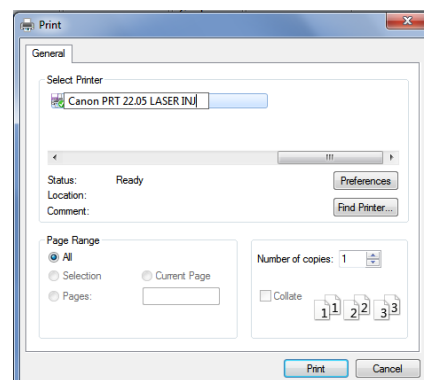

3. Double-click the PrintPlt.exe file, then the “Print” dialog box will be displayed, in the dialog box you can select printer or change settings.
4. Click the OK button, the “Open” dialog box will be displayed and you can select the printed file.

**Batch Print:** Batch print drawings with the same drawing frame attribute.

**Menu:** Express tools>Plot Tool>Batch Print

**Command Entry:** BP

Operation steps:

1. Start the command.
2. Specify the type of frame, you can select Layer/ Block/ Polyline so that the system can recognize the frame.
3. Corner select the frame you want to print, you will get a dialog box.
4. Set the print Parameters, click “OK” to execute bath print.

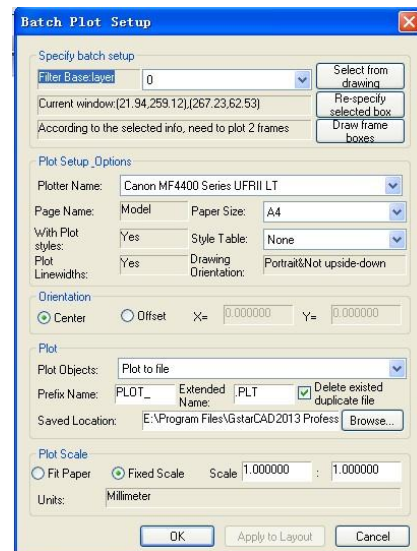

**Arrange Frame Automatically:** This function can search frames automatically, calculate according to the size of the frame and then arrange several drawings to a big drawing.

**Menu:** Express tools>Plot Tool>Arrange Frame Automatically

**Command Entry:** ZDPT

Operation steps:

1. Start the command, a dialog box will pop up.
2. In order to get a reasonable drawing plot arrangement, you can choose which industry you want to use in advance. Click “Options” and you will get a dialog box.

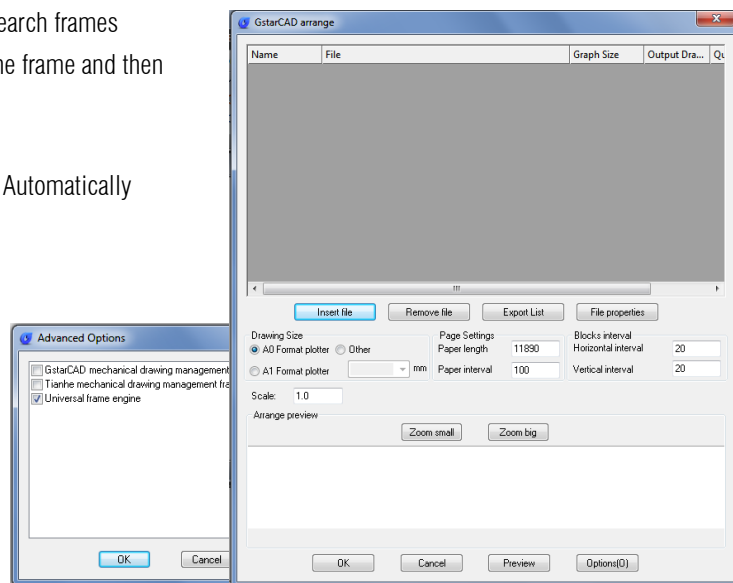

3. Click “Insert files”, a “Add file Manner” dialog box will pop up, you can set the manner you like to add to the file.

**Folder:** This option will add all the DWG files from the root directory to the arranged list, if you check “File that contains subfolders” option and all the DWG files from subfolders will be added to the arranged list.

**Drawing list:** Add specified LST file list.

**File:** Add specified DWG file.

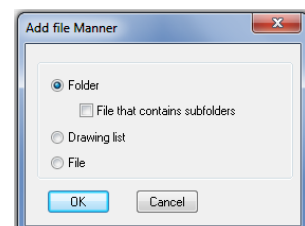

4. After selecting, all the files will be in the list.
5. Click the “Preview” button to preview the arrangement effect. The system will arrange the drawings intelligently according to the frame above.
6. If you are satisfied with the effect, you can click “OK”, then the system will arrange the drawings and insert the drawing frames into the current file.

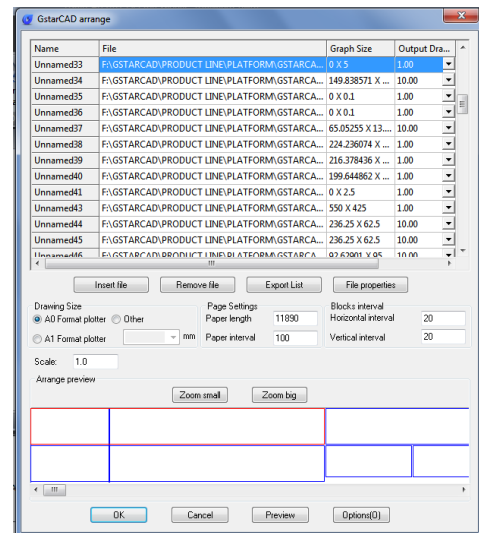



**GstarCAD 2021**



■ <https://www.gstarcad.net/>